

D660 Series
Servo-Proportional Control Valves
with Integrated Electronics
ISO 4401 Size 05 to 10

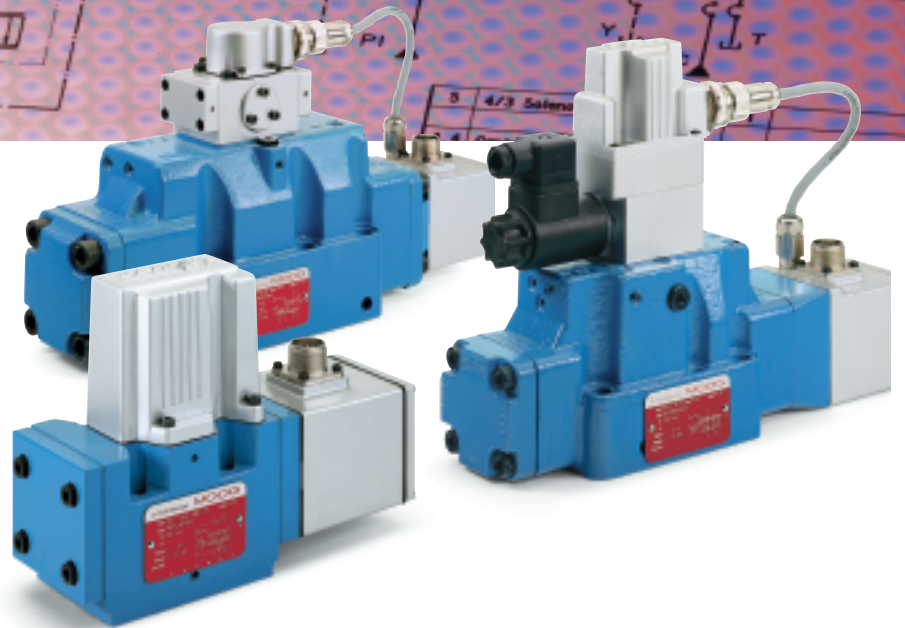
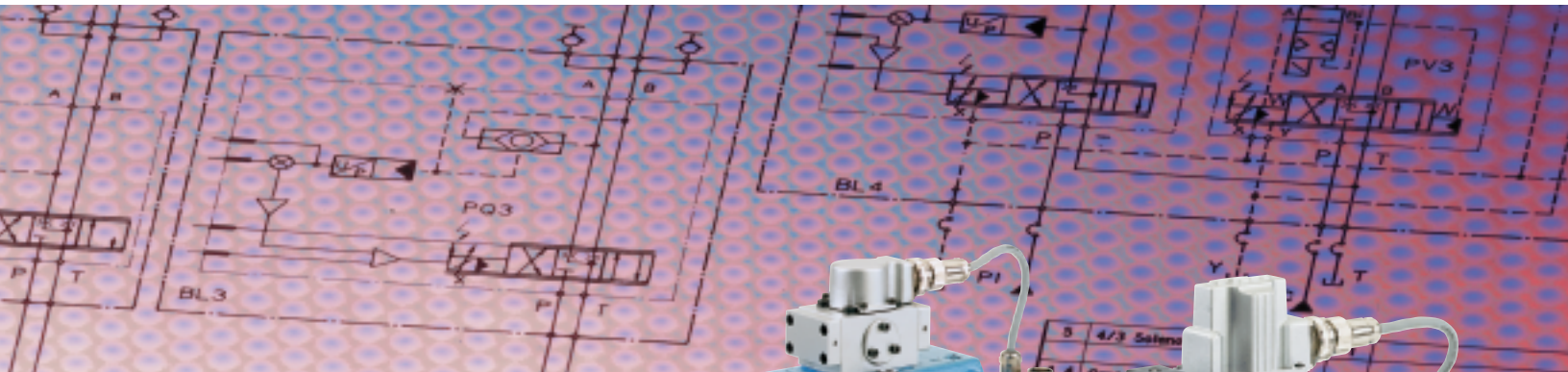

Section	Page
Overview	2-3
Technical Data	4-5
Electronics	6-9
Performance Specs.	10-19
Fail-Safe Versions	20-25
Ordering Information	26-27

MOOG SERVO-PROPORTIONAL CONTROL VALVES

For over 25 years Moog has manufactured proportional control valves with integrated electronics. During this time more than 150,000 valves have been delivered. These proportional control valves have been proven to provide reliable control of including injection and blow molding equipment, die casting machines, presses, heavy industry equipment, paper and lumber processing and other applications.

D660 SERIES SERVO-PROPORTIONAL CONTROL VALVES

The D660 Series proportional flow control valves are throttle valves for 2, 3, 4 and 5-way applications. These valves are suitable for electrohydraulic position, velocity, pressure or force control systems, including those with high dynamic response requirements.

Over time, Moog servo-proportional valves have undergone continuous improvements. Moog's ServoJet® pilot stage reduces energy consumption and enhances the valves robustness. This pilot stage uses the jet pipe principle, which has been used reliably with different Moog valves for over 10 years.

We have updated D660 Series servo-proportional valves with new integrated 24 V_{DC} electronics which improve valve dynamics significantly.

The improved D660 Series is designed to enhance the stability and performance of the valves in a wider variety of applications, increase the number of signal options and improve the fail-safe functionality of an application.

We have also redesigned the valve's ServoJet® pilot stage, reducing hysteresis and null shift and improving pressure gain. Also, the updated ServoJet® pilot stage now has the ability to operate at a plus or minus 150 mA rated signal.

The new integrated electronics improve valve dynamics by up to 30 percent and now have a 24 V_{DC} supply voltage, as well as 4 to 20 mA spool position output as options.

Changes in the D660 Series allow the 90° phase lag frequency response characteristic for small signals (10% amplitude) to increase from 78 Hz to 90 Hz in the D661 Series, (NG 10).

Other improvements in the D660 Series address many safety considerations in die-casting machines, injection-molding machines and presses. These include:

- The valve now places an enable signal at the operator's disposal. If no enabled signal is available, the spool in the second stage moves to a predefined position (hydraulic zero or end position) depending on valve variant.
- The valve monitors supply voltage. If voltage on the updated valve (18 V up to 32 V) should drop below 18 V, the end position will be disconnected and the spool will move to its predefined position (fail-safe). It will be monitored as soon as it reaches this position and will be confirmed by a logic output.
- The logic outputs are short circuit protected. Maximum continuous voltage is 32 V with surge pulses up to 500 V and burst of 4 kV (per EMC standard).

Fail-safe option

D660 valves are available with either a mechanical or electrically controlled fail-safe option. Certain conditions must exist for the fail-safe to work reliably. See the type designation section for fail-safe on page 20 for more information.

 Our quality management system is certified in accordance with DIN EN ISO 9001.

 The valve series described in this catalogue have successfully passed EMC tests required by EC Directive. Please refer to the respective references in the electronics section.

 Valves available with explosion protection to EN 50018, class EEx d LL C-C 2 H 2 T5.
Note: Installation dimensions and electric connection altered. Special data sheet on request.

This catalogue is for users with technical knowledge. To ensure that all necessary characteristics for function and safety of the system are given, the user has to check the suitability of the products described herein. In case of doubt please contact Moog.

Flexible Design Elements Optimize the Valve to Your Application

The D660 Series Proportional Control Valves are of two-stage or three-stage design. The spool motion of the main stage is produced by either a single-stage or a two-stage pilot valve. Two-stage proportional valves are mainly used when low threshold and good dynamic response with small signals are required. The three-stage proportional valves are suitable for good dynamic response with large signals.

By combining a fast first stage, a suitable spool drive area and integrated electronics, an optimum proportional valve can be offered.

Highest Flow Capability for High Velocity Applications

The D07 to D10 (NG 16 to NG 32) D660 Series valves offer the highest flow per body size.

Reduced Spool Drive Area for Improved Dynamic Response

The D07 to D10 (NG 16 to NG 32) D660 Series valves are available with a stub shaft spool for higher valve dynamic.

Fail-Safe Versions for User Defined Spool Position at Loss of Power

Mechanical and electrically controlled fail-safe versions provide defined safe spool position by a spring and/or a poppet valve, and/or by external hydraulic supply cut off.

Improved ServoJet® Pilot Stage Dynamics for High Dynamic Valve Design

The high natural frequency of the ServoJet® pilot stage (500 Hz) allows for higher overall valve dynamic.

Improved Frequency Response for Superior Control System Performance

Improved frequency response of the ServoJet® pilot stage valve allows high spool position loop gain. The high loop gain provides excellent static and dynamic response, resulting in superior control system performance.

High ServoJet® Pilot Stage Pressure Recovery for Reliable Operation

The high-pressure recovery of the ServoJet® pilot stage (more than 80% ΔP at 100% command signal) provides higher spool driving forces and ensures enhanced spool position repeatability.

Improved Resistance to Contamination Reduces Down Time

The ServoJet® pilot stage valves have larger internal clearances making it more tolerant to contamination. The pilot stage filter has almost unlimited life due to an increased filter size (200 μm nominal fineness).

2-Stage Proportional Control Valve

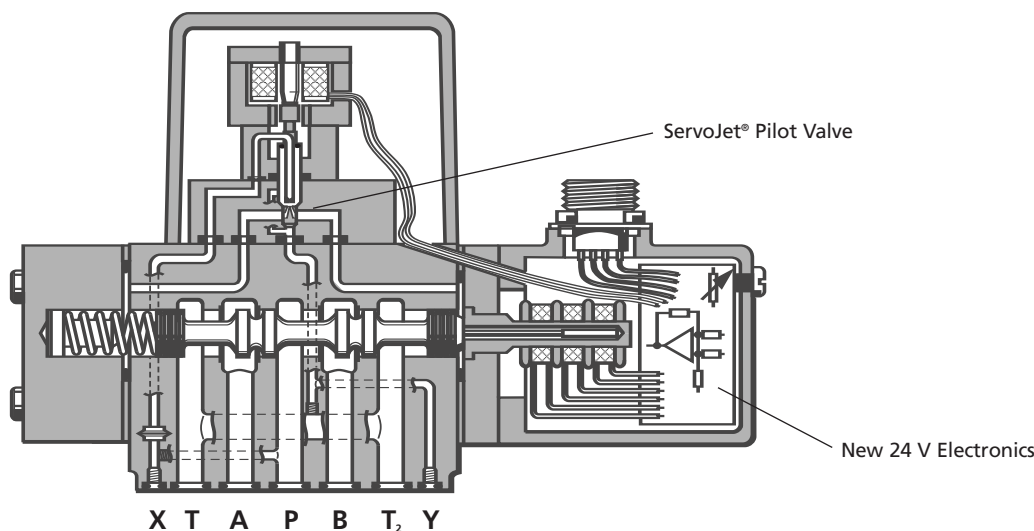

OPERATING PRINCIPLE OF THE SERVOJET PILOT STAGE

The ServoJet® pilot stage consists mainly of torque motor, jet pipe and receiver. A current through the coil displaces the jet pipe from its neutral position. This displacement combined with the special shape of the nozzle, directs a focused fluid jet from both receivers towards one receiver.

The jet now produces a pressure difference in the control ports. This pressure difference results in a pilot flow, which in turn causes a spool displacement. The pilot stage drain is through the annular area around the nozzle to tank.

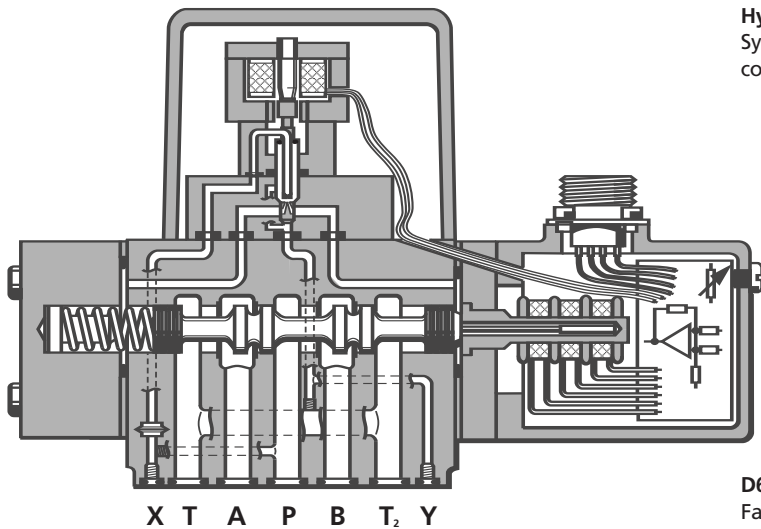

Hydraulic Symbol:

Symbol shown with pilot pressure and electric supply on and zero command signal.

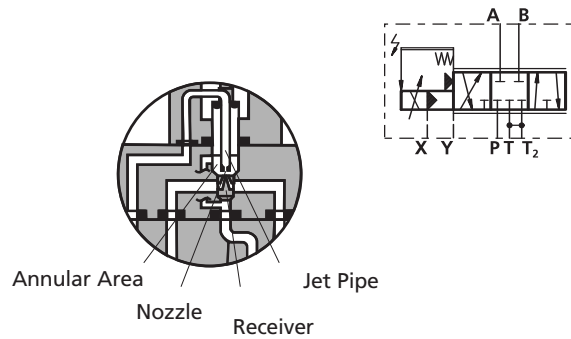

D661 Series, 2-stage proportional control valve
Fail-safe version F, opening A \blacktriangleright T

OPERATING PRINCIPLE OF THE MULTI-STAGE VALVE

The position control loop for the main stage spool is closed by the integrated electronics. An electrical command signal (flow rate set point) is applied to the integrated position controller which drives the valve coil. The position transducer (LVDT) which is excited via an oscillator, measures the position of the main spool (actual value, position voltage).

This signal is then demodulated and fed back to the controller where it is compared with the command signal. The controller drives the pilot valve until the error between command signal and feedback signal is zero. Thus, the position of the main spool is proportional to the electrical command signal.

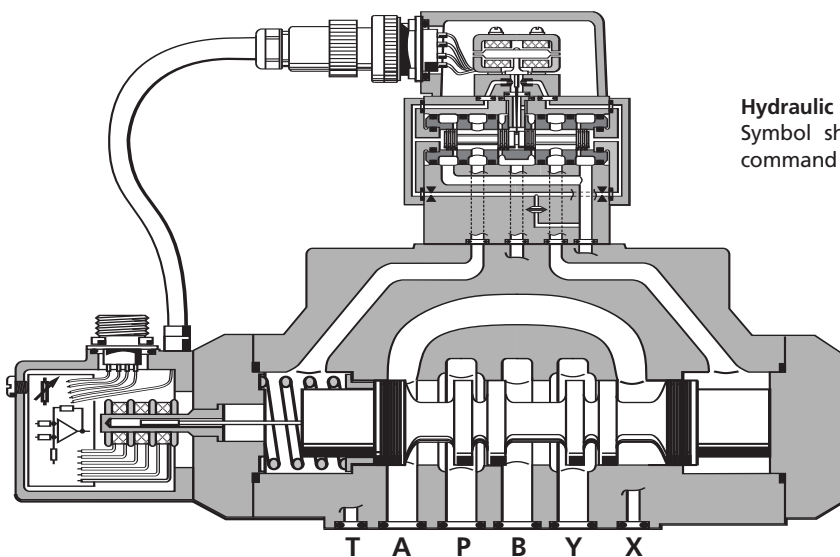

Hydraulic symbol:

Symbol shown with pilot pressure and electric supply on and zero command signal.

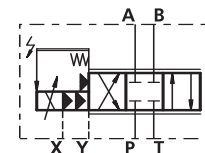

D662 Series with pilot valve D630 Series
3-Stage Proportional Control Valve
Fail-safe version F, opening A \blacktriangleright T

PERFORMANCE SPECIFICATIONS FOR STANDARD MODELS

Operating Pressure Range

Port P, A and B up to 5,000 psi [350 bar]
 Port T see data of individual series

Temperature Range

Ambient -4°F to +140°F [-20°C to +60°C]
 Fluid -4°F to +176°F [-20°C to +80°C]

Seal Material

NBR, FPM and others on request

Operating Fluid

mineral oil based hydraulic fluid (DIN 51524, part 1 to 3), other fluids on request

Viscosity

Recommended 15 to 45 mm²/s
 Allowable 5 to 400 mm²/s

System Filtration

Pilot stage or pilot valve: high pressure filter (without bypass, but with dirt alarm) mounted in the main flow and if possible directly upstream of the valve.

Main stage: high pressure filter as for the pilot stage. In combination with a fast regulating VD-pump, a bypass filter is possible.

Class of Cleanliness

The cleanliness of the hydraulic fluid greatly effects the performance (spool positioning, high resolution) and wear (metering edges, pressure gain, leakage) of the valve.

Recommended Cleanliness Class

For normal operation: ISO 4406 < 16/13
 For longer life: ISO 4406 < 14/11

Filter Rating recommended

For normal operation: β₁₅ ≥ 75 (15 μm absolute)
 For longer life: β₁₀ ≥ 75 (10 μm absolute)

Installation Options

any position, fixed or movable

Vibration

30 g, 3 axes

Degree of Protection

EN60529 class IP 65, with mating connector mounted

Shipping Plate

Delivered with an oil sealed shipping plate under the mounting surface.

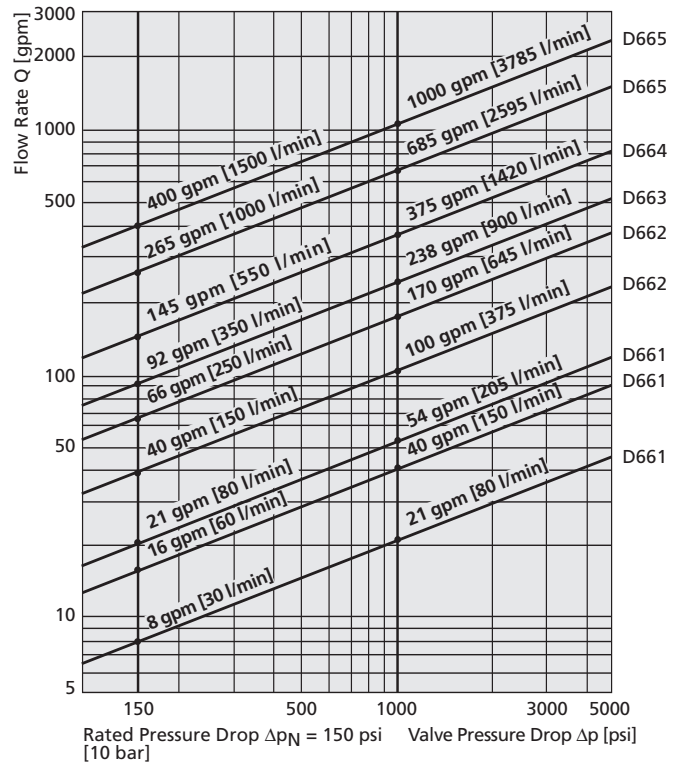

Valve Flow Diagram

Valve flow for maximum valve opening (100% command signal) as a function of the valve pressure drop

VALVE FLOW CALCULATIONS

A valve's flow is dependent upon its electrical command signal and valve pressure drop. The flow for a given valve pressure drop can be calculated using the square root function for sharp edged orifices as follows:

$$Q = Q_N \sqrt{\frac{\Delta p}{\Delta p_N}}$$

Q [gpm] = calculated flow

Q_N [gpm] = rated flow

Δp [psi] = actual valve pressure drop

Δp_N [psi] = rated valve pressure drop

If large flow rates with high valve pressure drop are required, an appropriate higher pilot pressure has to be selected in order to overcome the flow forces. An approximate value can be calculated as follows:

$$P_x \geq 3.8 \cdot 10^{-2} \cdot \frac{Q}{A_k} \cdot \sqrt{\Delta p}$$

Q [gpm] = max. flow

Δp [psi] = valve pressure drop with Q

A_k [in²] = spool drive area

P_x [psi] = pilot pressure

The pilot pressure p_x has to be at least 215 psi above the return pressure of the pilot stage.

GENERAL REQUIREMENTS FOR VALVE ELECTRONICS

- > Supply 24 V_{DC}, min. 18 V_{DC}, max. 32 V_{DC}. Current consumption max. 300 mA
- > All signal lines, also those of external transducers, shielded
- > Shielding connected radially to \perp (0 V), power supply side and connected to the mating connector housing (EMC)
- > **EMC:** Meets the requirements of EN 55011:1998 class B, EN 50082-2:1995, performance criteria class A
- > Protective grounding lead $\geq .75 \text{ mm}^2$ [18 AWG]
- > Note: When making electrical connections to the valve (shield, protective grounding), appropriate measures must be taken to ensure that locally different earth potentials do not result in excessive ground currents.

VALVE ELECTRONICS WITH SUPPLY VOLTAGE 24 VOLT AND 6+PE POLE CONNECTOR

Command Signal

0 to ±10 mA Floating, Valves with Current Command Input

The spool stroke of the valve is proportional to $I_D = -I_E$. 100% valve opening P → A and B → T is achieved at $I_D = +10$ mA. At 0 mA command the spool is in its center position. The input pins D and E are inverting. Either pin D or E is used according to the required operating direction. The other pin is connected to signal ground at cabinet side.

Command signal

0 to ±10 V Valves with Voltage Command Input

The spool stroke of the valve is proportional to $(U_D - U_E)$. 100% valve opening P → A and B → T is achieved at $(U_D - U_E) = +10$ V. At 0 V command the spool is in its center position. The input stage is a differential amplifier. If only one command signal is available, pin D or E is connected to signal ground at cabinet side, according to the required operating direction.

Actual Value 4 to 20 mA

The actual spool position value can be measured at pin F (see diagram below). This signal can be used for monitoring and fault detection purposes.

The spool stroke range corresponds to 4 to 20 mA. The centered position is at 12 mA. 20 mA corresponds to 100% valve opening P → A and B → T.

The position signal output 4 to 20 mA allows to detect a cable break when $I_F = 0$ mA.

For failure detection purposes it is advised to connect pin F of the mating connector and route this signal to the control cabinet.

CIRCUIT DIAGRAM

Circuit Diagram for Measurement of Actual I_F (Position of Main Spool) for Valves with 6+PE Pole Connector

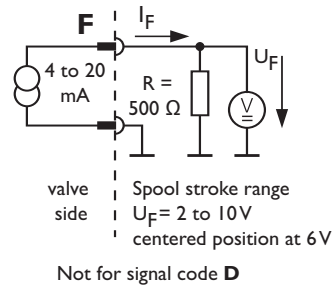

Note: Enable input

With enable signal off, the main spool will move to a safe position.

- a) Centered position (unbiased pilot valve function code A¹⁾)
- b) End position (biased pilot valve function code B¹⁾)

¹⁾ see type designation

CONNECTOR WIRING

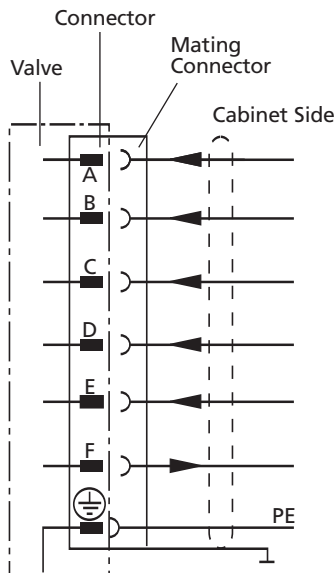

Wiring for valves with 6+PE pole connector to EN 175201 Part 804²⁾, and mating connector (type R and S, metal shell) with leading protective earth connection ⊕.

Function	Voltage Command	Current Command
Supply	24 V _{DC} (min. 18 V _{DC} , max. 32 V _{DC})	I _{max} : 300 mA
Supply/Signal Ground	⊥ (0 V)	
Enabled Not Enabled	U _{C-B} > 8.5 V _{DC} U _{C-B} < 6.5 V _{DC}	I _e = 1.2 mA at +24 V _{DC} (see note above)
Input Rated Command (differential)	U _{D-E} = 0 to ±10 V R _e = 10 kΩ	Input Command I _D = -I _E : 0 to ±10 mA (R _i =500 Ω) Input Command (Inverted) I _E = -I _D : 0 to ±10 mA
Output Actual Value spool position	Input voltage for U _{D-B} and U _{E-B} for both signal types is limited to min. -15 V and max. 32 V I _{F-B} : = 4 to 20 mA. At 12 mA spool is in centered position. R _i = 100 to 500 Ω Signal code D (see page 27): U _{F-B} = 2 to 10 V. At 6 V spool is in centered position. R _s = 500 Ω	
Protective Earth		

²⁾ formerly DIN 43563

VALVE ELECTRONICS WITH SUPPLY VOLTAGE 24 VOLT AND 11+PE POLE CONNECTOR

Command Signal

0 to ±10 mA Floating, Valves with Current Command Input

The spool stroke of the valve is proportional to $I_4 = -I_5$. 100% valve opening P → A and B → T is achieved at $I_4 = +10$ mA. At 0 mA command the spool is in a defined centered position. The input pins 4 and 5 are inverting. Either pin 4 or 5 is used according to the required operating direction. The other pin is connected to signal ground at cabinet side.

Command Signal

0 to ±10 V Valves with Voltage Command Input

The spool stroke of the valve is proportional to $(U_4 - U_5)$. 100% valve opening P → A and B → T is achieved at $(U_4 - U_5) = +10$ V. At 0 V command the spool is in a defined centered position. The input stage is a differential amplifier. If only one command signal is available, pin 4 or 5 is connected to signal ground at cabinet side, according to the required operating direction.

Actual Value 4 to 20 mA

The actual spool position value can be measured at pin 6 (see diagram below). This signal can be used for monitoring and fault detection purposes. The spool stroke range corresponds to 4 to 20 mA. The centered position is at 12 mA. 20 mA corresponds to 100% valve opening P → A and B → T.

The position signal output 4 to 20 mA allows to detect a cable break when $I_6 = 0$ mA.

For failure detection purposes, it is advised to connect pin 6 of the mating connector and route this signal to the control cabinet.

CIRCUIT DIAGRAM

Circuit Diagram for Measurement of Actual I_6 (Position of Main Spool) for Valves with 11+PE Pole Connector

Note: Enable input

With enable signal off, the main spool will move to a safe position.

- a) Centered position (unbiased pilot valve function code E¹⁾)
- b) End position (biased pilot valve function code F¹⁾)

¹⁾ see type designation

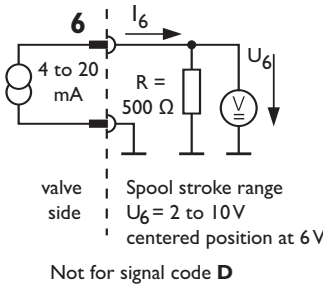

CONNECTOR WIRING

Wiring for valves with 11+PE pole connector to EN 175201 (Part 804²⁾) and mating connector (type E, metal shell) with leading protective earth connection \oplus .

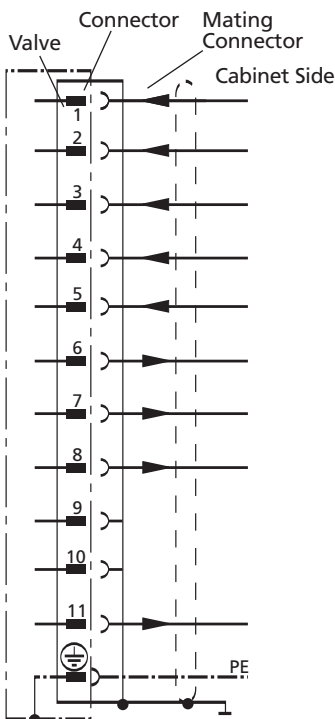

Function	Voltage Command	Current Command
Supply	24 V _{DC} (min. 18 V _{DC} , max. 32 V _{DC}) I _{max} : 300 mA	
Supply/Signal Ground	⊥ (0 V)	
Enabled Not Enabled	U ₃₋₂ > 8.5 V _{DC} U ₃₋₂ < 6.5 V _{DC}	I _e = 1.2 mA at +24 V _{DC} (see note above)
Input Rated Command (differential)	U ₄₋₅ = 0 to ±10 V R _e = 10 kΩ	Input Command I ₄ = -I ₅ ; 0 to ±10 mA (R _e =200 Ω) Input Command (Inverted) I ₅ = -I ₄ ; 0 to ±10 mA
Output Actual Value Spool Position	I ₆₋₂ = 4 to 20 mA. At 12 mA spool is in centered position. R _l = 100 to 500 Ω Signal code D (see page 27): U ₆₋₂ = 2 to 10 V. At 6 V spool is in centered position. R _a = 500 Ω	
Auxiliary Signal	Spool position U ₇₋₂ = 13 to 3 V. At 8 V spool is in centered position. R _a = 5 kΩ	
Valve Ready	U ₈₋₂ > 8.5 V _{DC} : Enable and supply ok U ₈₋₂ < 6.5 V _{DC} : Not enabled or supply not ok	Output I _{max} : 20 mA
Not Used		
Not Used		
Position Error, Logic	U ₁₁₋₂ > 8.5 V _{DC} : < 30% U ₁₁₋₂ < 6.5 V _{DC} : > 30%	Output I _{max} : 20 mA
Protective Earth		

²⁾ formerly DIN 43651

FAIL-SAFE VALVE ELECTRONICS WITH SUPPLY VOLTAGE 24 VOLT AND 11+PE POLE CONNECTOR

Command Signal

0 to ±10 V Valves with Voltage Command Input

The spool stroke of the valve is proportional to $I_4 = -I_5$. 100% valve opening P → A and B → T is achieved at $I_4 = 10$ mA. At 0 mA command the spool is in a defined centered position. The input pins 4 and 5 are inverting. Either pin 4 or 5 is used according to the required operating direction. The other pin is connected to signal ground at cabinet side.

Command Signal

0 to ±10 V Valves with Voltage Command Input

The spool stroke of the valve is proportional to $(U_4 - U_5)$. 100% valve opening P → A and B → T is achieved at $(U_4 - U_5) = +10$ V. At 0 V command the spool is in a defined centered position. The input stage is a differential amplifier. If only one command signal is available, pin 4 or 5 is connected to signal ground at cabinet side, according to the required operating direction.

Actual Value 4 to 20 mA

The actual spool position value can be measured at pin 6 (see diagram below). This signal can be used for monitoring and fault detection purposes. The spool stroke range corresponds to 4 to 20 mA. The centered position is at 12 mA. 20 mA corresponds to 100% valve opening P → A and B → T.

The position signal output 4 to 20 mA allows to detect a cable break when $I_6 = 0$ mA.

For failure detection purposes, it is advised to connect pin 6 of the mating connector and route this signal to the control cabinet.

CIRCUIT DIAGRAM

Circuit Diagram for Measurement of Actual I_6 (Position of Main Spool) for Valves with 11+PE Pole Connector

Note: Enable input

With enable signal off, the main spool will move to a safe position.

- a) Centered position (unbiased pilot valve function code G¹⁾)
- b) End position (biased pilot valve function code H¹⁾)

¹⁾ see type designation

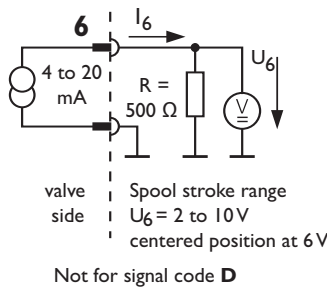

CONNECTOR WIRING

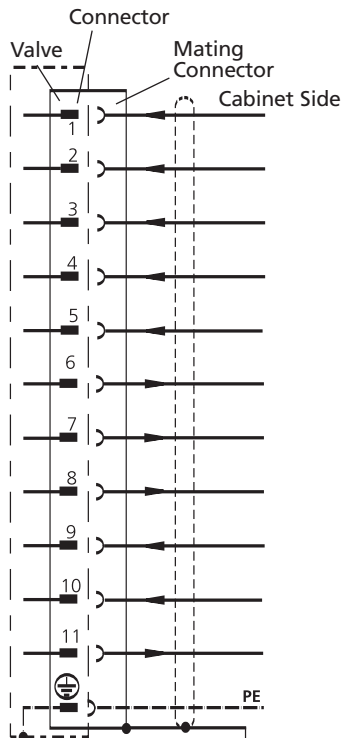

Wiring for valves with 11+PE pole connector to EN 175201 (Part 804²⁾) and mating connector (type E, metal shell) with leading protective earth connection ⊕.

Function	Voltage Command	Current Command
Supply	24 V _{DC} (min. 18 V _{DC} , max. 32 V _{DC}) I _{max} : 300 mA	
Supply/Signal Ground	⊥ (0 V)	
Enabled Not Enabled	U _{3:2} > 8.5 V _{DC} U _{3:2} < 6.5 V _{DC}	I _e = 1.2 mA at +24 V _{DC} (see note above)
Input Rated Command (differential)	U _{4:5} = 0 to ±10 V R _e = 10 kΩ	Input Command I ₄ = -I ₅ : 0 to ±10 mA (R _e = 200 Ω) Input Command (Inverted) I ₅ = -I ₄ : 0 to ±10 mA
Output Actual Value Spool Position	Input voltage for U _{4:2} and U _{5:2} for both signal types is limited to min. -15 V and max. 32 V I _{6:2} = 4 to 20 mA. At 12 mA spool is in centered position. R _L = 100 to 500 Ω Signal code D (see page 27): U _{6:2} = 2 to 10 V. At 6 V spool is in centered position. R _s = 500 Ω	
Auxiliary Signal	Spool position U _{7:2} = 13 to 3 V. At 8 V spool is in centered position. R _s = 5 kΩ	
Valve Ready	U _{8:2} > 8.5 V _{DC} : Enabled and supply ok U _{8:2} < 6.5 V _{DC} : Not enabled or supply not ok	Output I _{max} : 20 mA
Supply, 4/2-way Solenoid Valve	24 V _{DC} (min. 22.8 V _{DC} , max. 26.4 V _{DC})	
Supply, 4/2-way Solenoid Valve, Signal Ground	⊥ (0 V)	
Safe Position, Logic	U _{11:2} > 8.5 V _{DC} : safe position U _{11:2} < 6.5 V _{DC} : no safe position	Output I _{max} : 20 mA
Protective Earth		

²⁾ formerly DIN 43651

PERFORMANCE SPECIFICATIONS FOR STANDARD MODELS

		English [Metric]	D661 - P . . . A	D661 - P . . . B
Mounting Pattern	ISO with additional 2nd T port		ISO 4401 - 05 - 05 - 0 - 94	ISO 4401 - 05 - 05 - 0 - 94
Valve Body Version			4-way, 2 x 2-way and 5-way 2-stage, standard spool	4-way, 2 x 2-way and 5-way 2-stage, standard spool
Pilot Stage	ServoJet®		Standard	High flow
Pilot Connection	selectable, internal or external		X and Y	X and Y
Mass		lb [kg]	12.3 [5.6]	12.3 [5.6]
Rated Flow	(±10%) at $\Delta p_N = 75$ psi per land	gpm [l/min]	8 [30] / 16 [60] / 21[80] / 2 x 21[80]	8 [30] / 16 [60] / 21[80] / 2 x 21[80]
Operating Pressure	max.			
Main Stage:	port P, A, B	psi [bar]	5,000 [350]	5,000 [350]
	port T with Y internal	psi [bar]	3,000 [210]	3,000 [210]
	port T with Y external	psi [bar]	5,000 [350]	5,000 [350]
Pilot Stage:	regular version	psi [bar]	4,000 [280]	4,000 [280]
	with dropping orifice (on request)	psi [bar]	5,000 [350]	5,000 [350]
Response Time*	for 0 to 100% stroke	[ms]	28.0	18.0
Threshold*		[%]	< 0.05	< 0.05
Hysteresis*		[%]	< 0.30	< 0.30
Null Shift	with $\Delta T = 55$ K	[%]	< 1.0	< 1.0
Null Leakage Flow*	max. (~ critical lap)	gpm [l/min]	0.92 [3.5]	1.2 [4.4]
Pilot Leakage Flow*		gpm [l/min]	0.45 [1.7]	0.69 [2.6]
Pilot Flow*	for 100% step input	gpm [l/min]	0.45 [1.7]	0.69 [2.6]
Main Spool Stroke		in [mm]	±0.12 [3.0]	±0.12 [3.0]
Spool Drive Area		in ² [cm ²]	0.31 [2.0]	0.31 [2.0]

* measured at 3,000 psi [210 bar] pilot or operating pressure, respectively, fluid viscosity of 32 mm²/s and fluid temperature of 104°F [40°C]

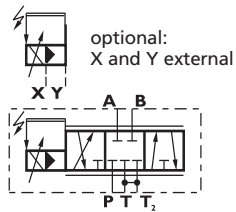

4-way version
(2nd T port required with $Q_N > 16$ gpm [60 l/min])

fail-safe position "M" if $p_x \leq 15$ psi [1 bar], only with X and Y external

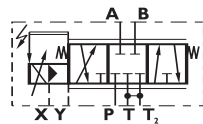

4-way version
spring centered (2nd T port required with $Q_N > 16$ gpm [60 l/min])

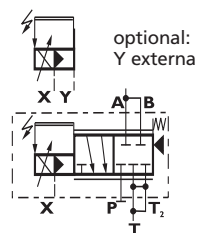

2 x 2-way version

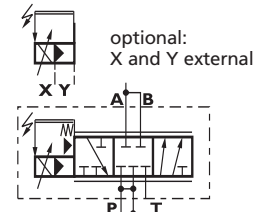

5-way version

PERFORMANCE SPECIFICATIONS FOR STANDARD MODELS

Flow vs. Signal Curve
at $\Delta p_N = 75$ psi [5 bar] per land

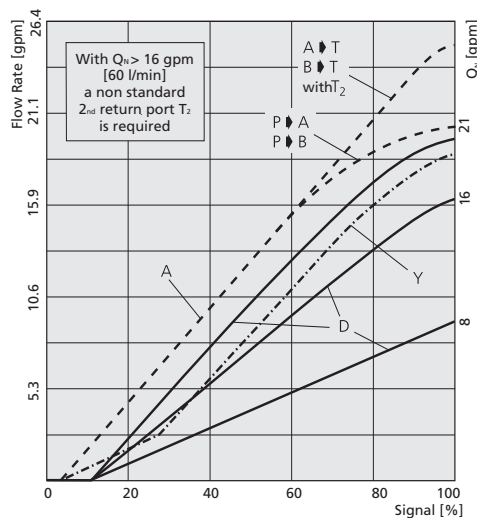

Spool version A: ~critical lap, linear characteristic (80)
Spool version D: 10% overlap, linear characteristic
Spool version Y: ~critical lap, curvilinear characteristic (80)

Typical characteristic curves measured at 3,000 psi [210 bar] pilot or operating pressure, fluid viscosity of 32 mm²/s and fluid temperature of 104°F [40°C]

D661 - P/B . . . A
Step Response

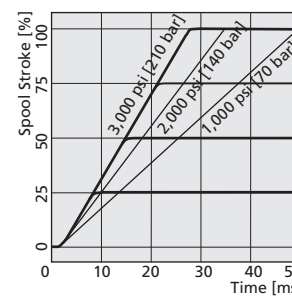

D661 - P/B . . . B

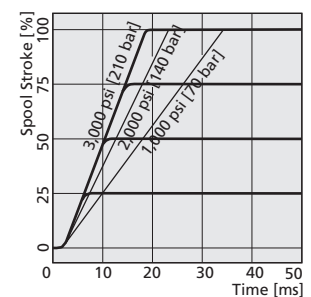

Frequency Response

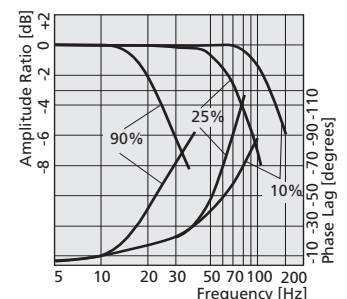
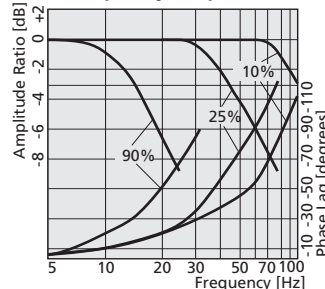

INSTALLATION DIAGRAM

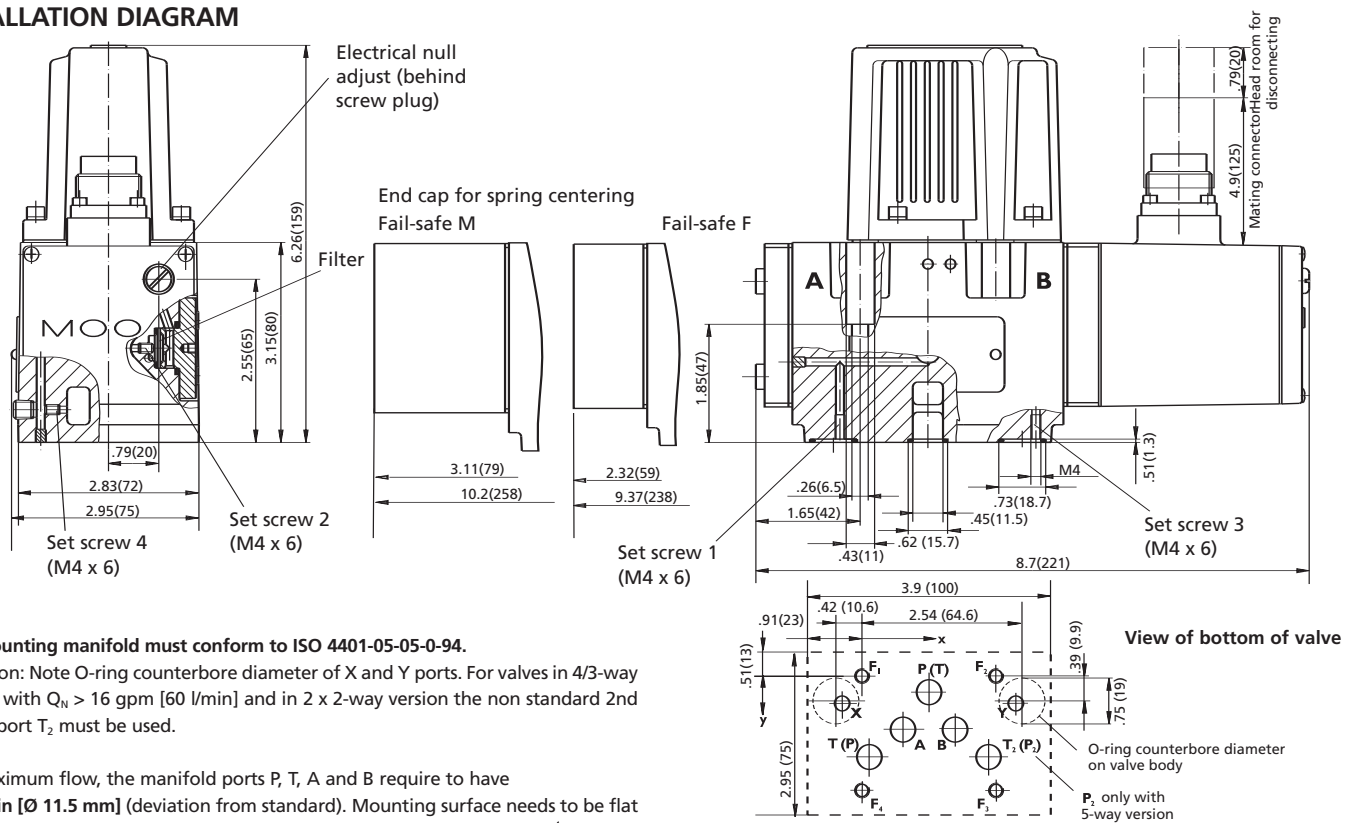

The mounting manifold must conform to ISO 4401-05-05-0-94.

Attention: Note O-ring counterbore diameter of X and Y ports. For valves in 4/3-way version with $Q_N > 16$ gpm [60 l/min] and in 2 x 2-way version the non standard 2nd return port T_2 must be used.

For maximum flow, the manifold ports P, T, A and B require to have $\varnothing 0.45$ in [$\varnothing 11.5$ mm] (deviation from standard). Mounting surface needs to be flat within .001 in [0.02 mm]. Average surface finish value, Ra, better than \sqrt{v} .

	P	A	B	T	T_2	X	Y	F ₁	F ₂	F ₃	F ₄
	$\varnothing 0.45$ [11.5]	$\varnothing 0.45$ [11.5]	$\varnothing 0.45$ [11.5]	$\varnothing 0.45$ [11.5]	$\varnothing 0.45$ [11.5]	$\varnothing 0.25$ [6.3]	$\varnothing 0.25$ [6.3]	M6	M6	M6	M6
x	1.06 [27.0]	0.66 [16.7]	1.47 [37.3]	0.13 [3.2]	2.0 [50.8]	-0.31 [-8.0]	2.44 [62.0]	0	2.13 [54.0]	2.13 [54.0]	0
y	0.25 [6.3]	0.84 [21.4]	0.84 [21.4]	1.28 [32.5]	1.28 [32.5]	0.43 [11.0]	0.43 [11.0]	0	0	1.81 [46.0]	1.81 [46.0]

CONVERSION INSTRUCTION

For main stage operation with internal or external pilot connection.	Pilot Flow Supply	Set Screw M4 x 6		Pilot Flow Return	Set Screw M4 x 6	
		bore 1	bore 2		bore 3	bore 4
Internal P	closed	open	closed	Internal T	closed	open
External X	open	closed	open	External Y	open	closed

SPARE PARTS AND ACCESSORIES

O-rings (included in delivery)											
for P, T, T_2 , A, B	5 pieces	ID 0.49 [12.4] x \varnothing 0.07 [1.8]						NBR 85 Shore		FPM 85 Shore	
for X, Y	2 pieces	ID 0.61 [15.6] x \varnothing 0.07 [1.8]						45122-004		42082-004	
Mating connector, waterproof IP65 (not included in delivery)											for cable diameter
6+PE pole	B97007-061			EN 175201 Part 804				min. \varnothing 0.39 [10.0], max. \varnothing 0.47 [12.0]			
11+PE pole	B97067-111			EN 175201 Part 804				min. \varnothing 0.43 [11.0], max. \varnothing 0.51 [13.0]			
Flushing plates		for P, A, B, T, T_2 , X, Y				for P, T, T_2 , X, Y					for P, T, T_2 , and X, Y
		B67728-001				B67728-002					B67728-003
Mounting manifolds		see special data sheet									
Mounting bolts (not included in delivery)								required torque		required	
M6 x 60 DIN EN ISO 4762-10.9	A03665-060-060							115 in-lb [13.0 Nm]		4 pieces	
Replaceable filter	A67999-200							200 μ m nominal			
O-rings for filter change											
filter	1 piece	ID 0.51 [12.0] x \varnothing 0.59 [2.0]						HNBR 85 Shore		NBR 85 Shore	
filter cover	1 piece	ID 0.67 [17.1] x \varnothing 0.78 [2.6]						B97009-080		FPM 85 Shore	
										66117-012-020	A25163-012-020

PERFORMANCE SPECIFICATIONS FOR STANDARD MODELS

	English [Metric]	D662 - D . . . A	D662 - D . . . B	D662 - P . . . M
Mounting Pattern		ISO 4401 - 07 - 06 - 0 - 94	ISO 4401 - 07 - 06 - 0 - 94	ISO 4401 - 07 - 06 - 0 - 94
Valve Body Version		4-way, 2 x 2-way	4-way, 2 x 2-way	4-way, 2 x 2-way
Pilot Stage		2-stage, stub shaft spool	2-stage, stub shaft spool	3-stage, standard spool
Pilot Connection	selectable, internal or external	D061 Series ServoJet, 1-stage	D061 Series ServoJet, 1-stage	D630 Series, 2-stage
Mass	lb[kg]	X and Y 24 [11]	X and Y 25 [11.5]	X and Y 25 [11.5]
Rated Flow	(±10%) at $\Delta p_N = 75$ psi per land	39.6 [150] / 66.1 [250]	39.6 [150] / 66.1 [250]	39.6 [150] / 66.1 [250]
Operating Pressure	max.			
Main Stage:				
port P, A, B	psi [bar]	5,000[350]	5,000[350]	5,000[350]
port T with Y internal	psi [bar]	2,000[140]	2,000[140]	3,000[210]
port T with Y external	psi [bar]	5,000[350]	5,000[350]	5,000[350]
Pilot Stage:				
regular version	psi [bar]	4,000[280]	4,000[280]	4,000[280]
with dropping orifice (on request)	psi [bar]	5,000[350]	5,000[350]	—
port T	psi [bar]	2,000[140]	2,000[140]	3,000[210]
Response Time*	for 0 to 100% stroke	[ms]	44.0 28.0	9.0
Threshold*		[%]	< 0.10	< 0.20
Hysteresis*		[%]	< 0.50	< 1.0
Null Shift	with $\Delta T = 55$ K	[%]	< 1.0	< 1.5
Null Leakage Flow*	max. (~ critical lap)	gpm [l/min]	1.1 [4.2]	1.3 [5.1]
Pilot Leakage Flow*		gpm [l/min]	0.45 [1.7]	0.69 [2.6]
Pilot Flow*	for 100% step input	gpm [l/min]	0.45 [1.7]	0.69 [2.6]
Main Spool Stroke		in [mm]	±0.2 [5.0]	±0.2 [5.0]
Spool Drive Area		in ² [cm ²]	0.31 [2.0]	0.31 [2.0]

* measured at 3,000 psi [210 bar] pilot or operating pressure, respectively, fluid viscosity of 32 mm²/s and fluid temperature of 104°F [40°C]

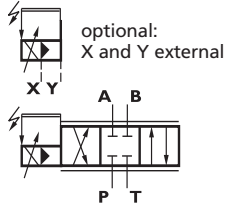

4-way version

fail-safe position "M"
if $p_x \leq 15$ psi,
only with X and Y external



4-way version
spring centered

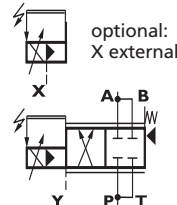

2 x 2-way version

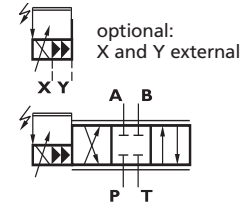

4-way version
3-stage valve

PERFORMANCE SPECIFICATIONS FOR STANDARD MODELS

Flow vs. Signal Curve
at $\Delta p_N = 75$ psi [5 bar] per land

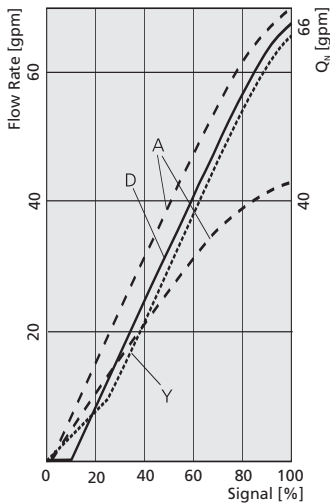

A: ~critical lap, linear
D: 10% overlap, linear
Y: ~critical lap, curvilinear

Typical characteristic curves measured at 3,000 psi [210 bar] pilot or operating pressure, fluid viscosity of 32 mm²/s and fluid temperature of 104°F [40°C]

D662 - D . . . A
Step Response

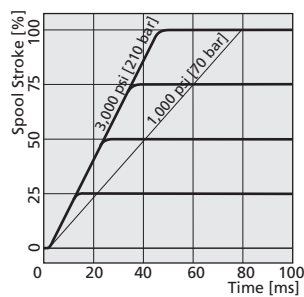

Frequency Response

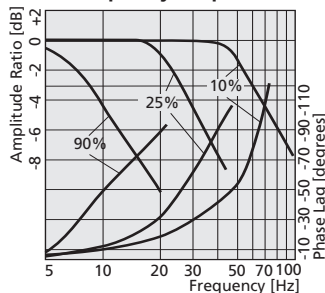

D662 - D . . . B
Step Response

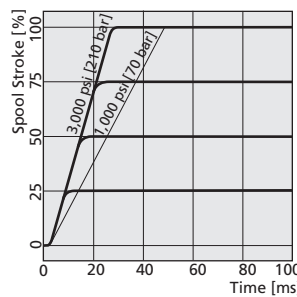

Frequency Response

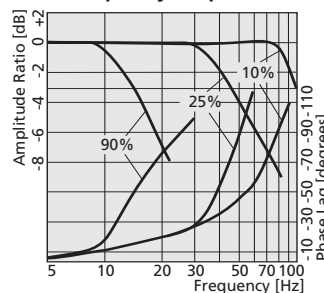

D662 - P . . . M

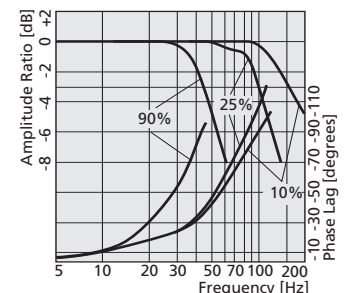
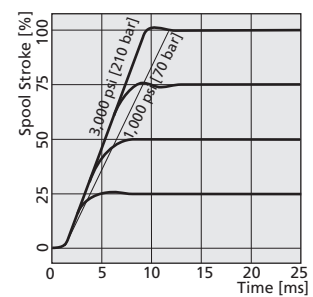

INSTALLATION DIAGRAM

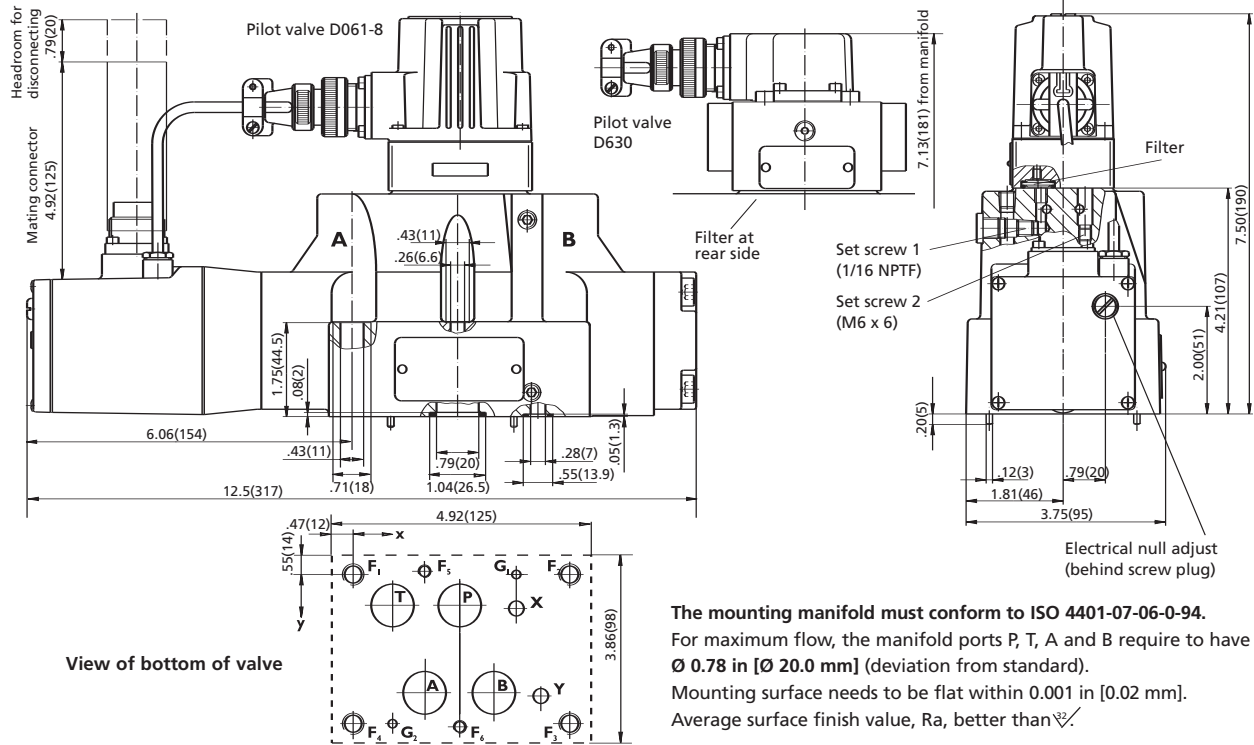

The mounting manifold must conform to ISO 4401-07-06-0-94.
 For maximum flow, the manifold ports P, T, A and B require to have $\varnothing 0.78$ in [$\varnothing 20.0$ mm] (deviation from standard).
 Mounting surface needs to be flat within 0.001 in [0.02 mm].
 Average surface finish value, Ra, better than $\sqrt{2}$.

	P	A	T	B	X	Y	G ₁	G ₂	F ₁	F ₂	F ₃	F ₄	F ₅	F ₆
	$\varnothing 0.79$ [$\varnothing 20$]	$\varnothing 0.79$ [$\varnothing 20$]	$\varnothing 0.79$ [$\varnothing 20$]	$\varnothing 0.79$ [$\varnothing 20$]	$\varnothing 0.25$ [6.3]	$\varnothing 0.25$ [6.3]	$\varnothing 0.16$ [4.0]	$\varnothing 0.16$ [4.0]	M10	M10	M10	M10	M6	M6
X	1.97 [50.0]	1.34 [34.1]	0.72 [18.3]	2.59 [65.9]	3.02 [76.6]	3.47 [88.1]	3.02 [76.6]	0.72 [18.3]	0	4.0 [101.6]	4.0 [101.6]	0	1.34 [34.1]	1.97 [50.0]
y	0.56 [14.3]	2.19 [55.6]	0.56 [14.3]	2.19 [55.6]	0.63 [15.9]	2.25 [57.2]	0	2.75 [69.9]	0	0	2.75 [69.9]	2.75 [69.9]	-0.06 [-1.6]	2.81 [71.5]

CONVERSION INSTRUCTION

For main stage operation with internal or external pilot connection.	Pilot Flow Supply	Set Screw bore 1 (1/16 NPTF)	Pilot Flow Return	Set Screw bore 2 (M6 x 6)
	Internal P	open	Internal T	open
External X	closed	External Y	closed	

SPARE PARTS AND ACCESSORIES

O-rings (included in delivery)			NBR 85 Shore	FPM 85 Shore
for P, T, A, B	4 pieces ID 0.86 [21.9] x \varnothing 0.103 [2.6]		45122-129	42082-129
for X, Y	2 pieces ID 0.43 [10.8] x \varnothing 0.07 [1.8]		45122-022	42082-022
Mating connector, waterproof IP65 (not included in delivery)			for cable diameter	
6+PE pole	B97007-061		EN 175201 Part 804	min. \varnothing 0.39 [10.0], max. \varnothing 0.47 [12.0]
11+PE pole	B97067-111		EN 175201 Part 804	min. \varnothing 0.43 [11.0], max. \varnothing 0.51 [13.0]
Flushing plates	76741			
Mounting manifold	B46891-001			
Mounting bolts (not included in delivery)			required torque	required
M10 x 60 DIN EN ISO 4762-10.9	A03665-100-060		575 in-lb [65.0 Nm]	4 pieces
M6 x 55 DIN EN ISO 4762-10.9	A03665-060-055		115 in-lb [13.0 Nm]	2 pieces
Replaceable filter				
for pilot valve D061-8	A67999-200		200 μ m nominal	
for pilot valve D630	A67999-065		65 μ m nominal	
O-rings for filter change			HNBR 85 Shore	NBR 85 Shore
D061-8: before filter	1 piece ID 0.55 [14.0] x \varnothing 0.039 [1.0]	A67008-014-010	—	—
behind filter	1 piece ID 0.51 [13.0] x \varnothing 0.059 [1.5]	A67008-013-015	—	—
D630: before and behind	2 piece ID 0.51 [13.0] x \varnothing 0.059 [1.5]	—	66117-013-015	A25163-013-015

PERFORMANCE SPECIFICATIONS FOR STANDARD MODELS

English [Metric]			D663 - L . . . B	D663 - P . . . M
Mounting Pattern			ISO 4401 - 08 - 07 - 0 - 94	ISO 4401 - 08 - 07 - 0 - 94
Valve Body Version			4-way, 2 x 2-way	4-way, 2 x 2-way
Pilot Stage			2-stage, stub shaft spool	3-stage, standard spool
Pilot Connection	selectable, internal or external		D061 Series ServoJet, 1-stage	D630 Series, 2-stage
Mass		lb [kg]	X and Y	X and Y
Rated Flow	(±10%) at $\Delta p_N = 75$ psi per land max.	gpm [l/min]	41.9 [19.0]	43.0 [19.5]
Operating Pressure			92.5 [350]	92.5 [350]
Main Stage:	port P, A, B	psi [bar]	5,000 [350]	5,000 [350]
	port T with Y internal	psi [bar]	2,000 [140]	3,000 [210]
	port T with Y external	psi [bar]	5,000 [350]	5,000 [350]
Pilot Stage:	regular version	psi [bar]	4,000 [280]	4,000 [280]
	with dropping orifice (on request)	psi [bar]	5,000 [350]	—
	port T	psi [bar]	2,000 [140]	3,000 [210]
Response Time*	for 0 to 100% stroke	[ms]	37.0	13.0
Threshold*		[%]	< 0.1	< 0.2
Hysteresis*		[%]	< 0.5	< 1.0
Null Shift	with $\Delta T = 55$ K	[%]	< 1.0	< 1.5
Null Leakage Flow*	max. (~ critical lap)	gpm [l/min]	1.5 [5.6]	1.3 [5.0]
Pilot Leakage Flow*		gpm [l/min]	0.69 [2.6]	0.53 [2.0]
Pilot Flow*	for 100% step input	gpm [l/min]	0.69 [2.6]	7.9 [30.0]
Main Spool Stroke		in [mm]	0.20 [±5.0]	0.20 [±5.0]
Spool Drive Area		in ² [cm ²]	0.43 [2.8]	1.77 [11.4]

* measured at 3,000 psi [210 bar] pilot or operating pressure, respectively, fluid viscosity of 32 mm²/s and fluid temperature of 104°F [40°C]

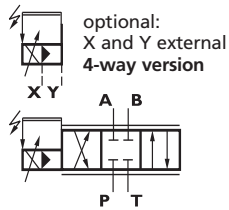

4-way version

fail-safe position "M" if $p_X \leq 1$ bar, only with X and Y external

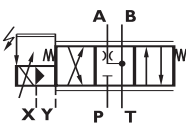

4-way version spring centered

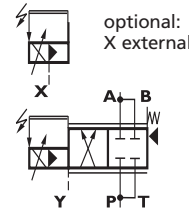

2 x 2-way version

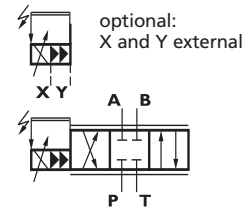

4-way version 3-stage valve

PERFORMANCE SPECIFICATIONS FOR STANDARD MODELS

Flow vs. Signal Curve at $\Delta p_N = 75$ psi per land [5 bar]

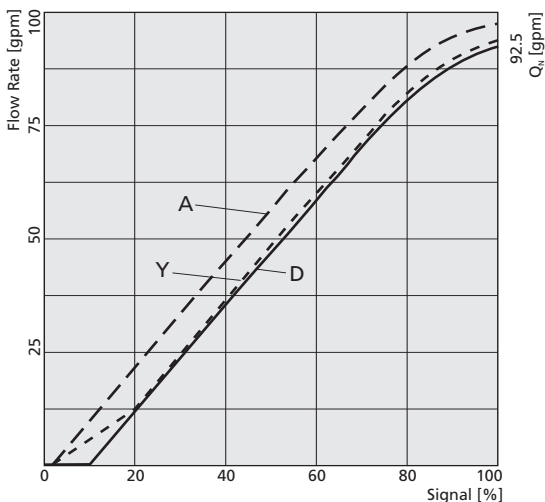

Spool version A: ~critical lap, linear characteristic
 Spool version D: 10% overlap, linear characteristic
 Spool version Y: ~critical lap, curvilinear characteristic

Typical characteristic curves measured at 3,000 psi [210 bar] pilot or operating pressure, fluid viscosity of 32 mm²/s and fluid temperature of 104°F [40°C]

D663 - L . . . B Step Response

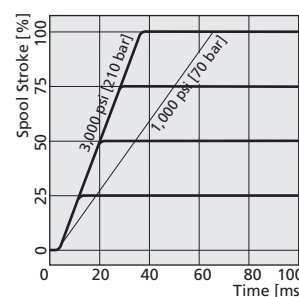

D663 - P . . . M

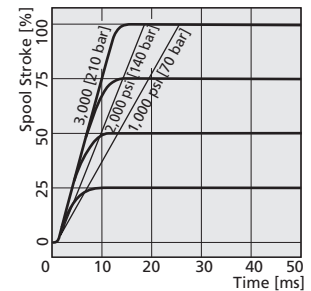

Frequency Response

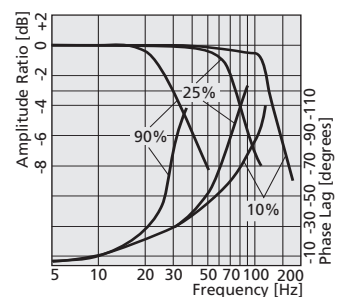
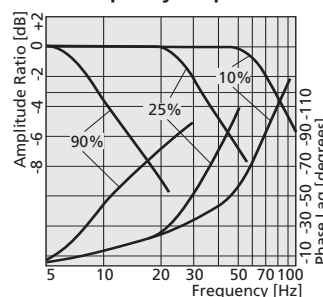

INSTALLATION DIAGRAM

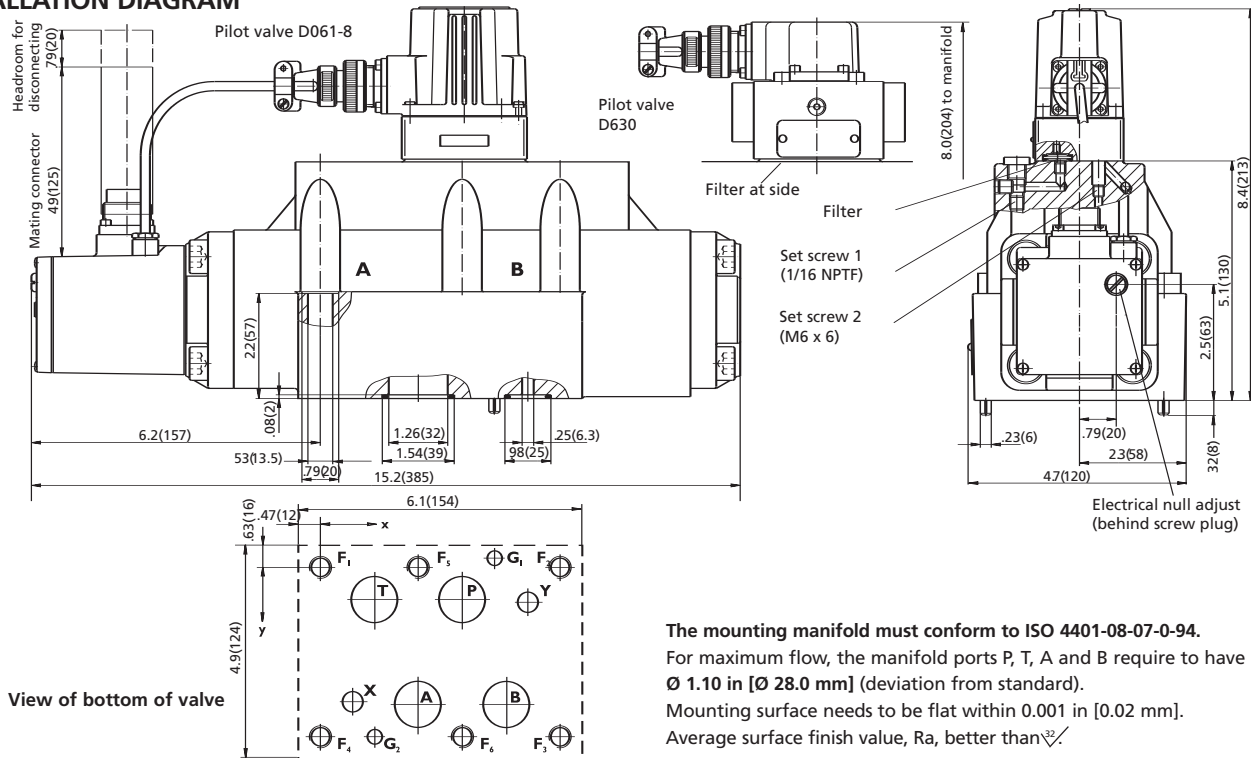

The mounting manifold must conform to ISO 4401-08-07-0-94.
 For maximum flow, the manifold ports P, T, A and B require to have $\varnothing 1.10$ in [$\varnothing 28.0$ mm] (deviation from standard).
 Mounting surface needs to be flat within 0.001 in [0.02 mm].
 Average surface finish value, Ra, better than $\sqrt{\text{ }}$.

	P	A	T	B	X	Y	G ₁	G ₂	F ₁	F ₂	F ₃	F ₄	F ₅	F ₆
	$\varnothing 1.1$ [28.0]	$\varnothing 1.1$ [28.0]	$\varnothing 1.1$ [28.0]	$\varnothing 1.1$ [28.0]	$\varnothing 0.44$ [11.2]	$\varnothing 0.44$ [11.2]	$\varnothing 0.30$ [7.5]	$\varnothing 0.30$ [7.5]	M12	M12	M12	M12	M12	M12
x	3.03 [77.0]	2.09 [53.2]	1.16 [29.4]	3.98 [100.8]	0.69 [17.5]	4.45 [112.7]	3.72 [94.5]	1.16 [29.4]	0	5.12 [130.2]	5.12 [130.2]	0	2.09 [53.2]	3.03 [77.0]
y	0.69 [17.5]	2.94 [74.6]	0.69 [17.5]	2.94 [74.6]	2.87 [73.0]	0.75 [19.0]	-0.19 [-4.8]	3.63 [92.1]	0	0	3.63 [92.1]	3.63 [92.1]	0	3.63 [92.1]

CONVERSION INSTRUCTION

For main stage operation with internal or external pilot connection.	Pilot Flow Supply	Set Screw bore 1 (1/16 NPTF)	Pilot Flow Return	Set Screw bore 2 (M6 x 6)
	Internal P External X	open closed	Internal T External Y	open closed

SPARE PARTS AND ACCESSORIES

O-rings (included in delivery) for P, T, A, B for X, Y	4 pieces ID 1.36 [34.6] x $\varnothing 0.10$ [2.6] 2 pieces ID 0.80 [20.3] x $\varnothing 0.10$ [2.6]	NBR 85 Shore 45122-113 45122-195	FPM 85 Shore 42082-113 42082-195
Mating connector, waterproof IP65 (not included in delivery) 6+PE pole 11+PE pole	B97007-061 B97067-111	EN 175201 Part 804 EN 175201 Part 804	for cable diameter min. $\varnothing 0.39$ [10.0], max. $\varnothing 0.47$ [12.0] min. $\varnothing 0.43$ in, max. $\varnothing 0.51$ [13.0]
Flushing plate	76047		
Mounting manifold	A25855-009		
Mounting bolts (not included in delivery) M12 x 75 EN ISO 4762-10.9	A03665-120-075	required torque 970 in-lb [110 Nm]	required 6 pieces
Replaceable filter for pilot valve D061-8 for pilot valve D630	A67999-200 A67999-065	200 μ m nominal 65 μ m nominal	
O-rings for filter change D061-8: before filter behind filter D630: filter before and behind	1 piece ID 0.55 [14.0] x $\varnothing 0.04$ [1.0] 1 piece ID 0.51 [13.0] x $\varnothing 0.06$ [1.5] 2 piece ID 0.51 [13.0] x $\varnothing 0.06$ [1.5]	HNBR 85 Shore A67008-014-010 A67008-013-015 —	NBR 85 Shore FPM 85 Shore — — 66117-013-015 A25163-013-015

PERFORMANCE SPECIFICATIONS FOR STANDARD MODELS

	English [Metric]	D664 - L . . . B	D664 - P . . . M
Mounting Pattern		ISO 4401 - 08 - 07 - 0 - 94	ISO 4401 - 08 - 07 - 0 - 94
Valve Body Version		4-way, 2 x 2-way 2-stage, stub shaft spool	4-way, 2 x 2-way 3-stage, standard spool
Pilot Stage		D061 Series ServoJet, 1-stage	D630 Series, 2-stage
Pilot Connection	selectable, internal or external	X and Y	X and Y
Mass	lb [kg]	41.9 [19.0]	43.0 [19.5]
Rated Flow	(±10%) at $\Delta p_N = 75$ psi per land	145 [550]	145 [550]
Operating Pressure	max.		
Main Stage:	port P, A, B	psi [bar]	5,000 [350]
	port T with Y internal	psi [bar]	2,000 [140]
	port T with Y external	psi [bar]	5,000 [350]
Pilot Stage:	regular version	psi [bar]	3,000 [280]
	with dropping orifice (on request)	psi [bar]	5,000 [350]
	port T	psi [bar]	2,000 [140]
Response Time*	for 0 to 100% stroke	[ms]	48.0
Threshold*		[%]	< 0.10
Hysteresis*		[%]	< 0.50
Null Shift	with $\Delta T = 55$ K	[%]	< 1.0
Null Leakage Flow*	max. (~ critical lap)	gpm [l/min]	1.5 [5.6]
Pilot Leakage Flow*		gpm [l/min]	0.69 [2.6]
Pilot Flow*	for 100% step input	gpm [l/min]	0.69 [2.6]
Main Spool Stroke		in [mm]	±0.24 [±6.0]
Spool Drive Area		in ² [cm ²]	0.43 [2.8]

* measured at 3,000 psi [210 bar] pilot or operating pressure, respectively, fluid viscosity of 32 mm²/s and fluid temperature of 104°F [40°C]

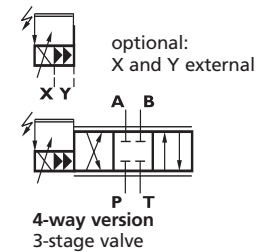
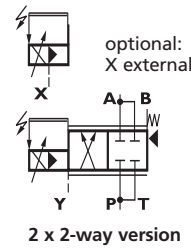
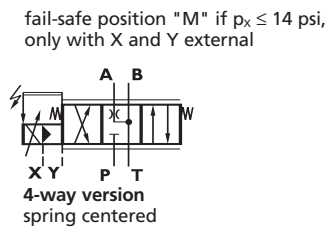
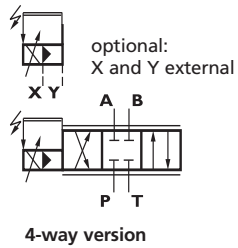

PERFORMANCE SPECIFICATIONS FOR STANDARD MODELS

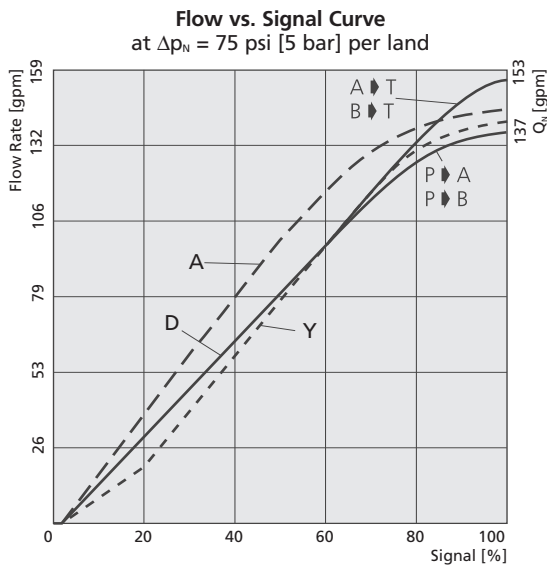

Spool version A: ~critical lap, linear characteristic
Spool version D: 10% overlap, linear characteristic
Spool version Y: ~critical lap, curvilinear characteristic

Typical characteristic curves measured at 3,000 psi [210 bar] pilot or operating pressure, fluid viscosity of 32 mm²/s and fluid temperature of 104°F [40°C]

D664 - L . . . B
Step Response

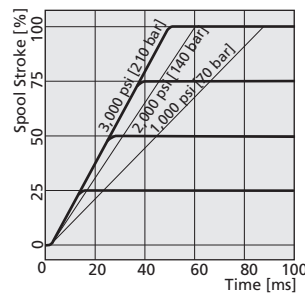

D664 - P . . . M

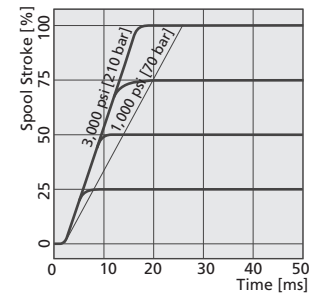

Frequency Response

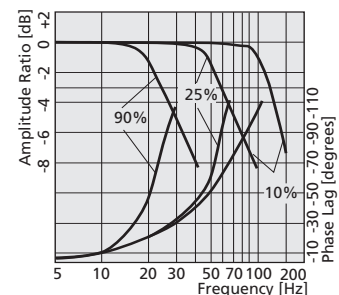
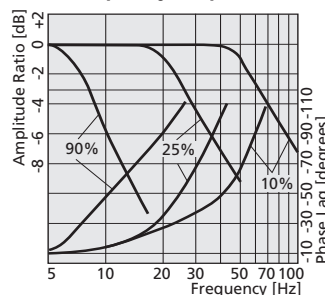

INSTALLATION DIAGRAM

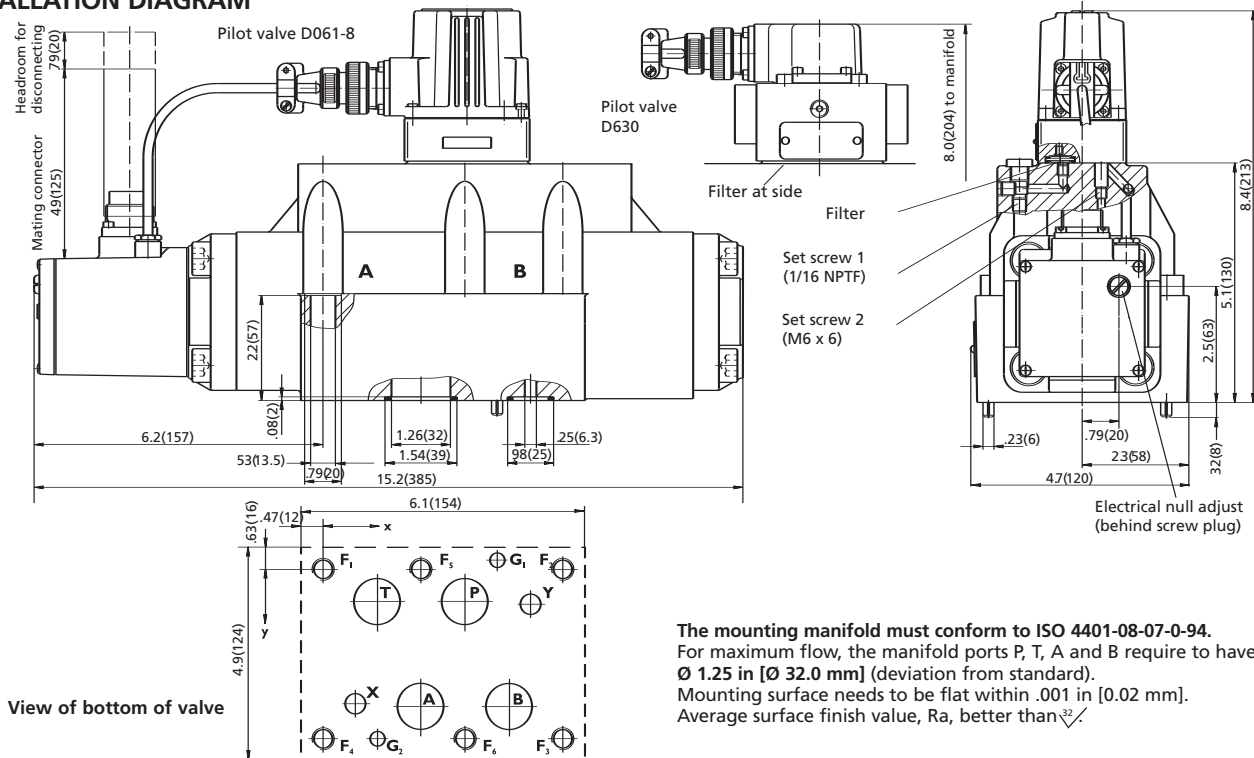

The mounting manifold must conform to ISO 4401-08-07-0-94.
 For maximum flow, the manifold ports P, T, A and B require to have \varnothing 1.25 in [\varnothing 32.0 mm] (deviation from standard).
 Mounting surface needs to be flat within .001 in [0.02 mm].
 Average surface finish value, Ra, better than $\sqrt{32}$.

	P	A	T	B	X	Y	G ₁	G ₂	F ₁	F ₂	F ₃	F ₄	F ₅	F ₆
	\varnothing 1.26 [32.0]	\varnothing 1.26 [32.0]	\varnothing 1.26 [32.0]	\varnothing 1.26 [32.0]	\varnothing 0.44 [11.2]	\varnothing 0.44 [11.2]	\varnothing 0.30 [7.5]	\varnothing 0.30 [7.5]	M12	M12	M12	M12	M12	M12
x	3.03 [77.0]	2.09 [53.2]	1.16 [29.4]	3.97 [100.8]	0.69 [17.5]	4.45 [112.7]	3.72 [94.5]	1.16 [29.4]	0	5.13 [130.2]	5.13 [130.2]	0	2.09 [53.2]	3.03 [77.0]
y	0.69 [17.5]	2.94 [74.6]	0.69 [17.5]	2.94 [74.6]	2.87 [73.0]	0.75 [19.0]	-0.19 [-4.8]	3.63 [92.1]	0	0	3.63 [92.1]	3.63 [92.1]	0	3.63 [92.1]

CONVERSION INSTRUCTION

For main stage operation with internal or external pilot connection.	Pilot Flow Supply	Set Screw bore 1 (1/16 NPTF)	Pilot Flow Return	Set Screw bore 2 (M6 x 6)
	Internal P External X	open closed	Internal T External Y	open closed

SPARE PARTS AND ACCESSORIES

O-rings (included in delivery) for P, T, A, B	4 pieces ID 1.36 [34.6] x \varnothing 0.10 [2.6]	NBR 85 Shore	FPM 85 Shore
for X, Y	2 pieces ID 0.80 [20.3] x \varnothing 0.10 [2.6]	45122-113	42082-113
Mating connector, waterproof IP65 (not included in delivery)		45122-195	42082-195
6+PE pole	B97007-061	EN 175201 Part 804	for cable diameter
11+PE pole	B97067-111	EN 175201 Part 804	min. \varnothing 0.39 [10.0], max. \varnothing 0.47 [12.0]
Flushing plate	76047		min. \varnothing 0.43 [11.0], max. \varnothing 0.51 [13.0]
Mounting manifold		A25855-009	
Mounting bolts (not included in delivery)		required	
M12 x 75 DIN EN ISO 4762-10.9	A03665-120 075	970 in-lb [110 Nm]	6 pieces
Replaceable filter			
for pilot valve D061-8	A67999-200	200 μ m nominal	
for pilot valve D630	A67999-065	65 μ m nominal	
O-rings for filter change		HNBR 85 Shore	NBR 85 Shore
D061-8: before filter	1 piece ID 0.55 [14.0] x \varnothing 0.04 [1.0]	A67008-014-010	FPM 85 Shore
behind filter	1 piece ID 0.51 [13.0] x \varnothing 0.06 [1.5]	A67008-013-015	—
D630: filter before and behind	2 piece ID 0.51 [13.0] x \varnothing 0.06 [1.5]	—	66117-013-015
			A25163-013-015

PERFORMANCE SPECIFICATIONS FOR STANDARD MODELS

	English [Metric]	D665 - P . . . H	D665 - K . . . L
Mounting Pattern Valve Body Version		ISO 4401 - 10 - 08 - 0 - 94 4-way, 2 x 2-way 3-stage, standard spool D631 Series, 2-stage optional X and Y	ISO 4401 - 10 - 08 - 0 - 94 4-way, 2 x 2-way 3-stage, stub shaft spool D661 Series ServoJet, 2-stage X and Y required
Pilot Stage			
Pilot Connection	selectable internal or external		
Mass	lb [kg]	154 [70.0]	162 [73.5]
Rated Flow (±10%) at ΔpN = 75 psi per land	gpm [l/min]	265 [1000] 400 [1500]	265[1000] 400[1500]
Operating Pressure	max.		
Main Stage:	psi [bar]	5000 [350]	5000 [350]
ports P with X external, A, B	psi [bar]	1400 [100]	1400 [100]
port T with Y internal	psi [bar]	5000 [350]	5000 [350]
port T with Y external	psi [bar]	3000 [210]	3000 [210]
Pilot Stage:	psi [bar]	3000 [210]	3000 [210]
regular version, ports P, A and B	psi [bar]	4000 [280]	5000 [350]
with dropping orifice (on request)	psi [bar]	2,000 [140] 2,000 [140]	3,000 [210]
port T			
Response Time*	for 0 to 100% stroke [ms]	30.0 35.0	10.0 12.0
Threshold*	[%]	< 0.30 < 0.20	< 0.30 < 0.20
Hysteresis*	[%]	< 1.0 < 0.70	< 1.0 < 0.70
Null Shift	with ΔT = 55 K [%]	< 2.0 < 1.5	< 2.5 < 2.0
Null Leakage Flow* max. (~ critical lap)	gpm [l/min]	2.8 [10.5]	2.9 [11.0]
Pilot Leakage Flow*	gpm [l/min]	0.92 [3.5]	1.1 [4.0]
Pilot Flow* for 100% step input	gpm [l/min]	11.9 [45.0] 14.5 [55.0]	10.6 [40.0] 13.2 [50.0]
Main Spool Stroke	in [mm]	±0.22 [±5.5] ±0.31 [±8]	±0.22 [±5.5] ±0.31 [±8.0]
Spool Drive Area	in ² [cm ²]	5.1 [33.2]	1.5 [9.6]

* measured at 3,000 psi [210 bar] pilot or operating pressure, respectively, fluid viscosity of 32 mm²/s and fluid temperature of 104°F [40°C]

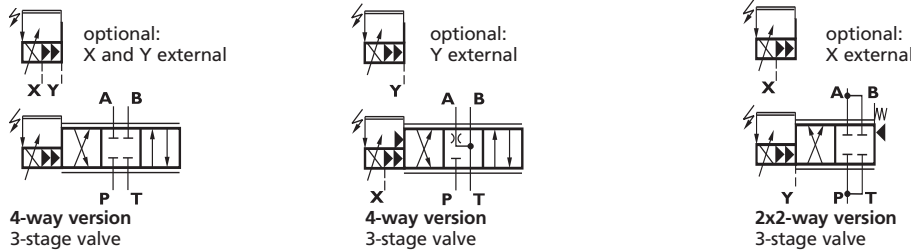

PERFORMANCE SPECIFICATIONS FOR STANDARD MODELS

Flow vs. Signal Curve
at ΔpN = 75 psi [5 bar] per land

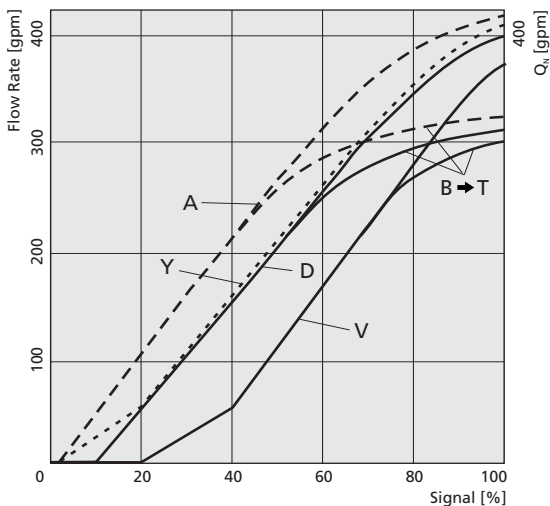

Spool version A: ~critical lap, linear characteristic
 Spool version D: 10 % overlap, linear characteristic
 Spool version Y: ~critical lap, curvilinear characteristic
 Spool version V: 20 % overlap, curvilinear characteristic

* measured at 3,000 psi [210 bar] pilot or operating pressure, respectively, fluid viscosity of 32 mm²/s and fluid temperature of 104°F [40°C]

D665 - P15 H
Step Response

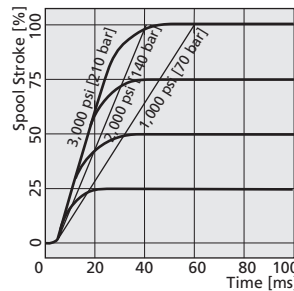

Frequency Response

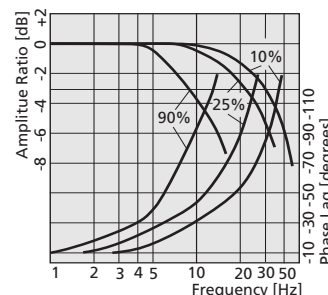

D665 - K15 J

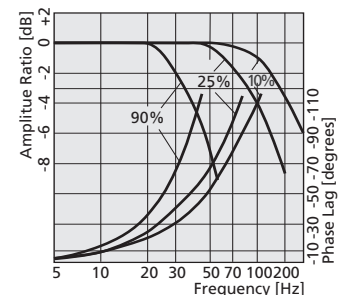
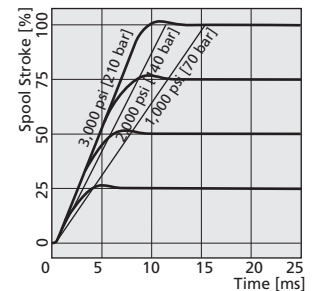

INSTALLATION DIAGRAM

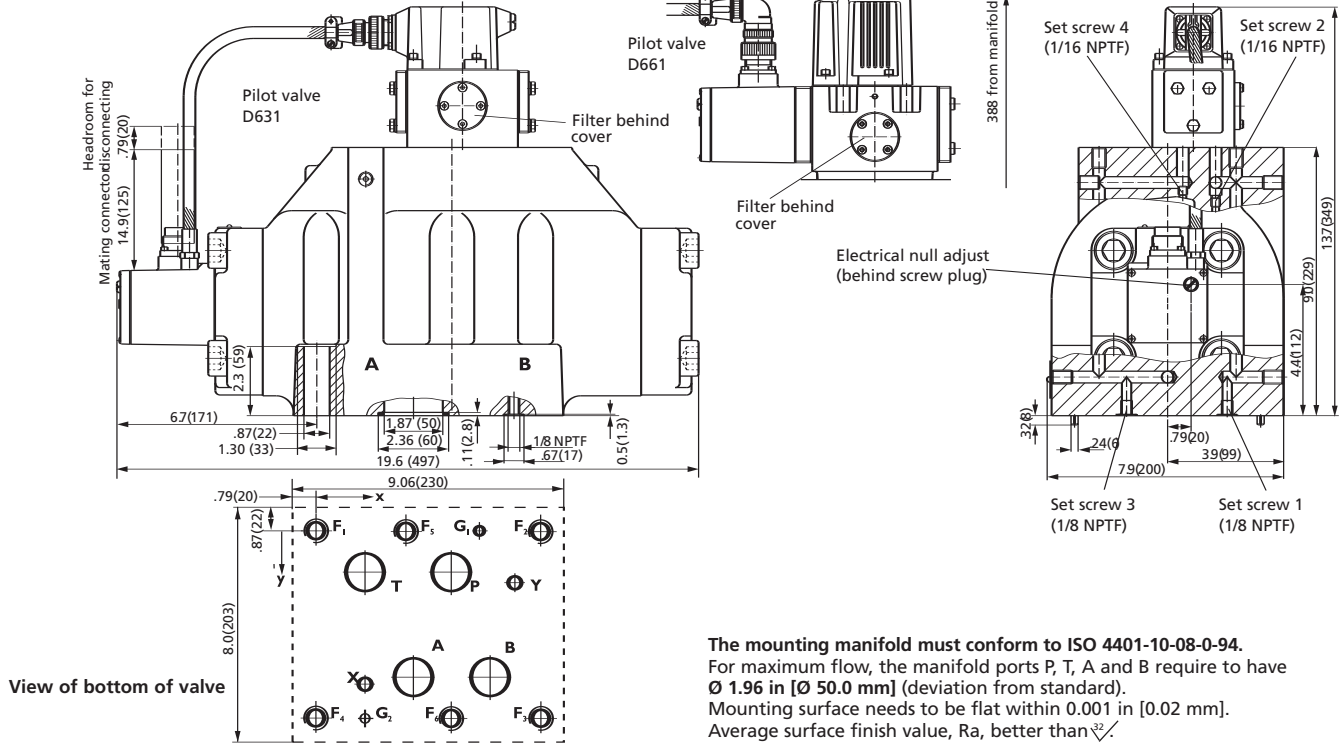

The mounting manifold must conform to ISO 4401-10-08-0-94. For maximum flow, the manifold ports P, T, A and B require to have $\varnothing 1.96$ in [$\varnothing 50.0$ mm] (deviation from standard). Mounting surface needs to be flat within 0.001 in [0.02 mm]. Average surface finish value, Ra, better than $\sqrt{32}$.

	P	A	T	B	X	Y	G ₁	G ₂	F ₁	F ₂	F ₃	F ₄	F ₅	F ₆
	$\varnothing 1.97$ [50.0]	$\varnothing 1.97$ [50.0]	$\varnothing 1.97$ [50.0]	$\varnothing 1.97$ [50.0]	$\varnothing 0.44$ [11.2]	$\varnothing 0.44$ [11.2]	$\varnothing 0.30$ [7.5]	$\varnothing 0.30$ [7.5]	M20	M20	M20	M20	M20	M20
x	4.49 [114.3]	3.25 [82.5]	1.63 [41.3]	5.81 [147.6]	1.63 [41.3]	6.63 [168.3]	5.81 [147.6]	1.63 [41.3]	0	7.5 [190.5]	7.5 [190.5]	0	3.0 [76.2]	4.5 [114.3]
y	1.38 [35.0]	4.87 [123.8]	1.38 [35.0]	4.87 [123.8]	5.13 [130.2]	1.75 [44.5]	0	6.25 [158.8]	0	0	6.25 [158.8]	6.25 [158.8]	0	6.25 [158.8]

CONVERSION INSTRUCTION

For main stage operation with internal or external pilot connection.	Pilot Flow Supply	Set Screw bore		Pilot Flow Return	Set Screw bore	
	Internal P External X	1 (1/8 NPTF) closed open	2 (1/16 NPTF) open closed	Internal T External Y	3 (1/8 NPTF) closed open	4 (1/16 NPTF) open closed

SPARE PARTS AND ACCESSORIES

O-rings (included in delivery) for P, T, A, B for X, Y	4 pieces ID 2.11 [53.6] x \varnothing 0.14 [3.5] 2 pieces ID 0.55 [14.0] x \varnothing 0.07 [1.8]	NBR 85 Shore 45122-035 45122-008	FPM 85 Shore 42082-035 42082-008
Mating connector, waterproof IP65 (not included in delivery) 6+PE pole 11+PE pole	B97007-061 B97067-111	EN 175201 Part 804 EN 175201 Part 804	for cable diameter min. \varnothing 0.39 [10.0], max. \varnothing 0.47 [12.0] min. \varnothing 0.43 [11.0], max. \varnothing 0.51 [13.0]
Flushing plate	not available		
Mounting manifold	A25856-001		
Mounting bolts (not included in delivery) M20 x 90 DIN EN ISO 4762-10.9	A03665-200-090	required torque 385 ft-lb [520 Nm]	required 6 pieces
Replaceable filter for pilot valve D631 and D661	A67999-100 A67999-200	100 μ m nominal 200 μ m nominal	
O-rings for filter change for pilot valves D631 and D661 filter filter cover D631 filter cover D661	1 piece ID 0.47 [12.0] x \varnothing 0.80 [2.0] 1 piece ID 0.67 [17.0] x \varnothing 0.80 [2.0] 1 piece ID 0.67 [17.1] x \varnothing 0.10 [2.6]	HNBR 85 Shore — B97009-080	NBR 85 Shore 66117-012-020 — FPM 85 Shore A25163-012-020 A25163-017-020 —

OPERATING PRINCIPLE OF THE FAIL-SAFE MULTI-STAGE VALVE

Application safety is dependent on the application itself, local safety requirements and design preferences. For applications where certain safety regulations are applicable, a defined metering spool position is needed in order to avoid potential damage. Various fail-safe versions are available for Moog servo-proportional control valves. To define the fail-safe operation in a D660 Series Valve, a complete understanding of the hydraulic circuit and country specific safety regulations is required. Following is information on the W, P and S electrically controlled fail-safe functionality. Contact Moog for additional information.

Fail-Safe Version W:

After switching off the 24 V supply to the safety solenoid valve, this fail-safe function causes a safe metering spool position: overlapped centered position or fully opened. In order to move the spool to the safe centered position with 2-stage proportional

valves, the two control chambers of the main stage are hydraulically short-circuited by a 2/2-way poppet valve. The spring force then moves the spool to the overlapped position.

Fail-Safe Version P:

Fail-safe version P is based on pilot pressure cut off. Both control chambers are then depressurized by leakage through the receiver. The spring force subsequently moves the spool to the safe position A \blacktriangleright T.

Fail-Safe Version W and S for D665 3 Stage Valves:

With D665 Series 3-stage proportional valves, the fail-safe function is implemented with a 4/2-way solenoid valve. In addition to the hydraulic short circuit of the two control chambers, the pilot stage pressure is switched off. The spring force moves the main spool to the safe position.

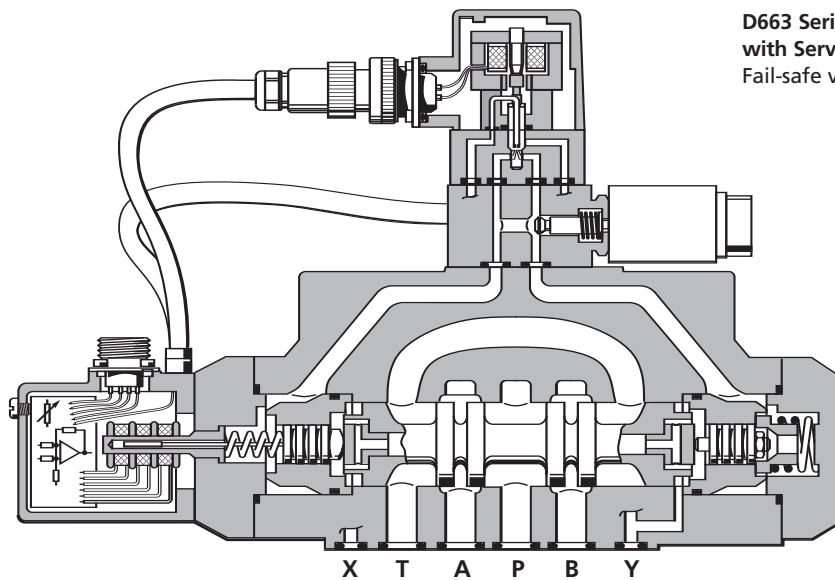

D663 Series two-stage proportional control valve with Servojet[®] pilot valve, 2/2-way poppet valve
Fail-safe version W

Note:
According to EN 954-1, a higher safety category can be achieved if a fail-safe valve is used.

ELECTRICAL CHARACTERISTICS

Electrical characteristics of the 2/2-way poppet valve (D661 to D664 Series, 2-stage) and 4/2-way solenoid valve (D665 Series) for the fail-safe version.

Valve version	
for D661 to D664	2/2-way solenoid poppet valve
for D665	4/2-way solenoid valve
Function	electromagnetic
Nominal voltage U_N	24 V _{DC} (min 22.8 V _{DC} , max 26.4 V _{DC})
Nominal power, P _N	
2/2-way poppet valve	26 W
4/2-way poppet valve	36 W

Connector wiring

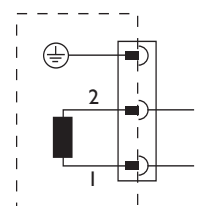

DIN 43650-1
Form A: 2+PE - PG9

Hydraulically activated valves for the fail-safe version on request.

INSTALLATION DIAGRAM

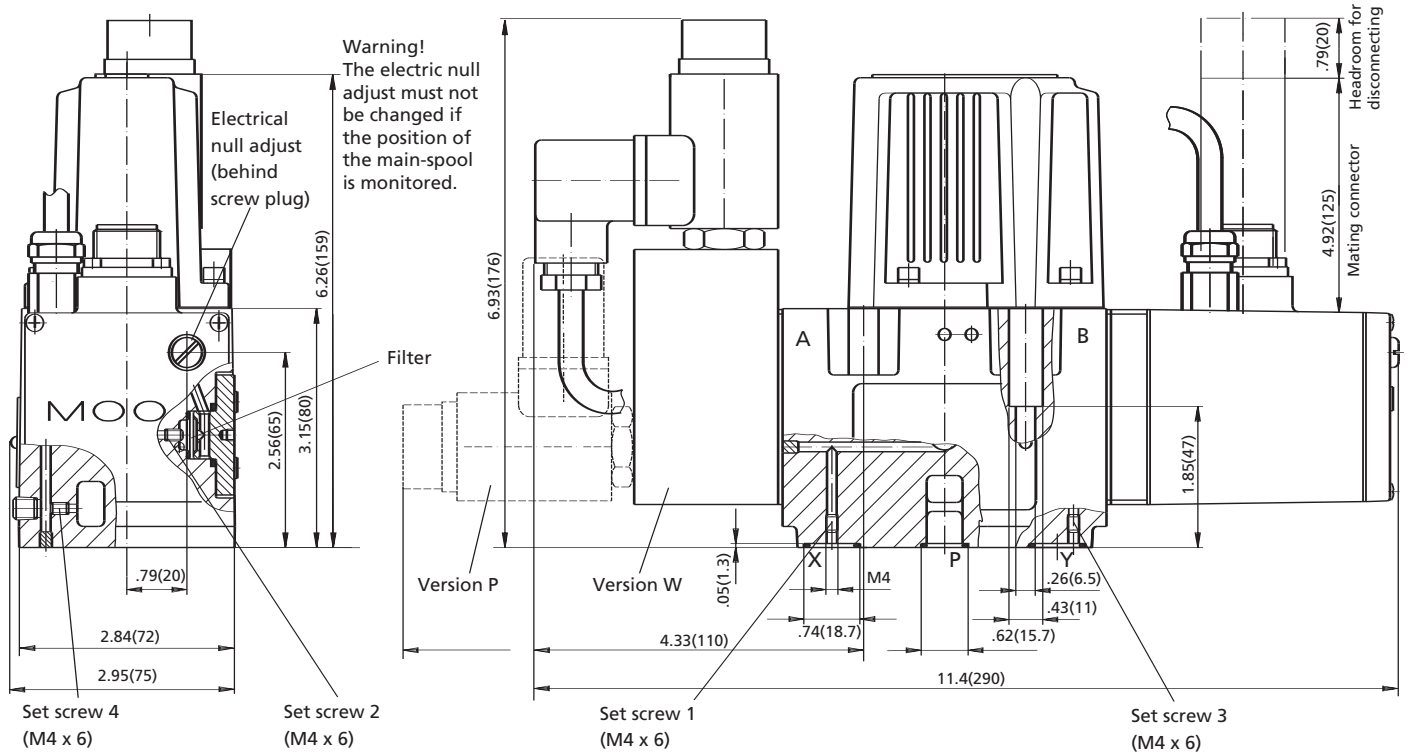

The mounting manifold must conform to ISO 4401-05-05-0-94 (see page 11).

Version with mechanical spring centering (fail-safe version M) see page 10 (symbol) and page 11 (installation drawing)

Fail-safe version P
Centered position, underlapped

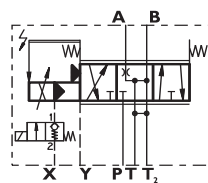

Fail-safe version W
Centered position, underlapped

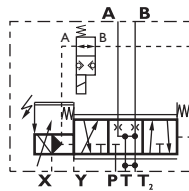

Fail-safe version W
Centered position, overlapped

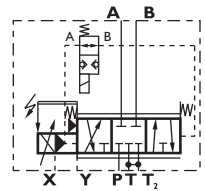

CONVERSION INSTRUCTION

For main stage operation with internal or external pilot connection.	Pilot Flow Supply	Set Screw M4 x 6		Pilot Flow Return	Set Screw M4 x 6	
		bore 1	bore 2		bore 3	bore 4
Internal P	closed	open	closed	Internal T	closed	open
External X	open	open	closed	External Y	open	closed

SPARE PARTS AND ACCESSORIES

Spare parts and accessories: Page 11

INSTALLATION DIAGRAM

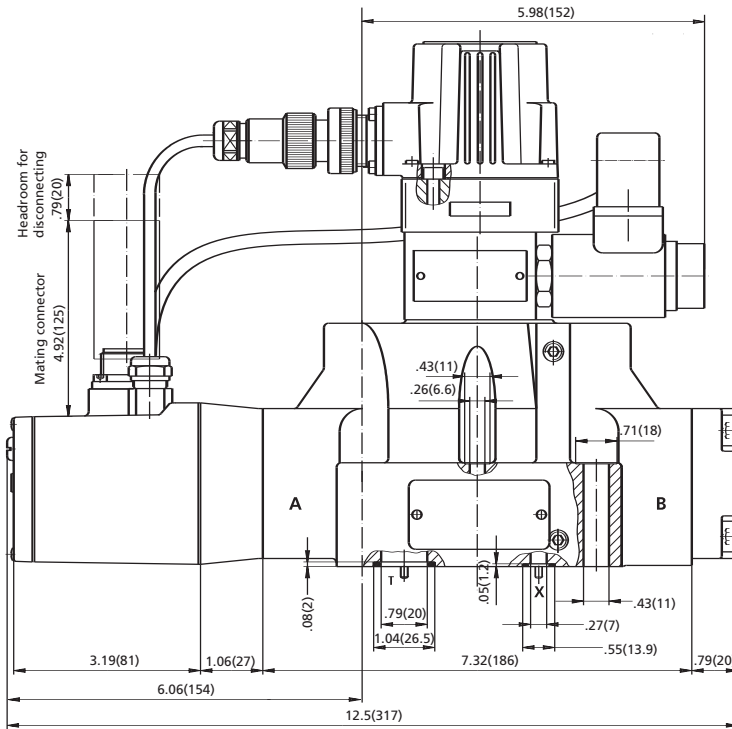

Warning!
The electric null adjust must not be changed if the position of the main-spool is monitored.

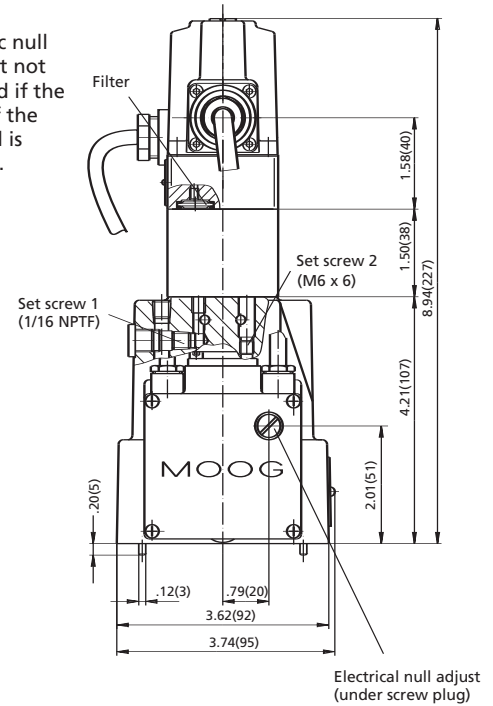

The mounting manifold must conform to ISO 4401-07-06-0-94 (see page 13).

Version with mechanical spring centering (spool position "M") see page 12 (symbol) and page 13 (installation drawing)

Fail-safe version P
Centered position, underlapped

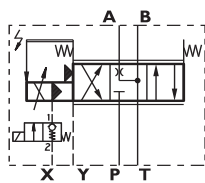

Fail-safe version W
Centered position, underlapped

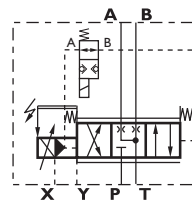

Fail-safe version W
Centered position, overlapped

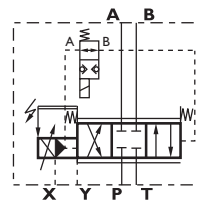

CONVERSION INSTRUCTION

For main stage operation with internal or external pilot connection.	Pilot Flow Supply	Set Screw bore 1 (1/16 NPTF)	Pilot Flow Return	Set Screw bore 2 (M6 x 6)
	Internal P External X	open closed	Internal T External Y	open closed

SPARE PARTS AND ACCESSORIES

Spare parts and accessories: Page 11

INSTALLATION DIAGRAM

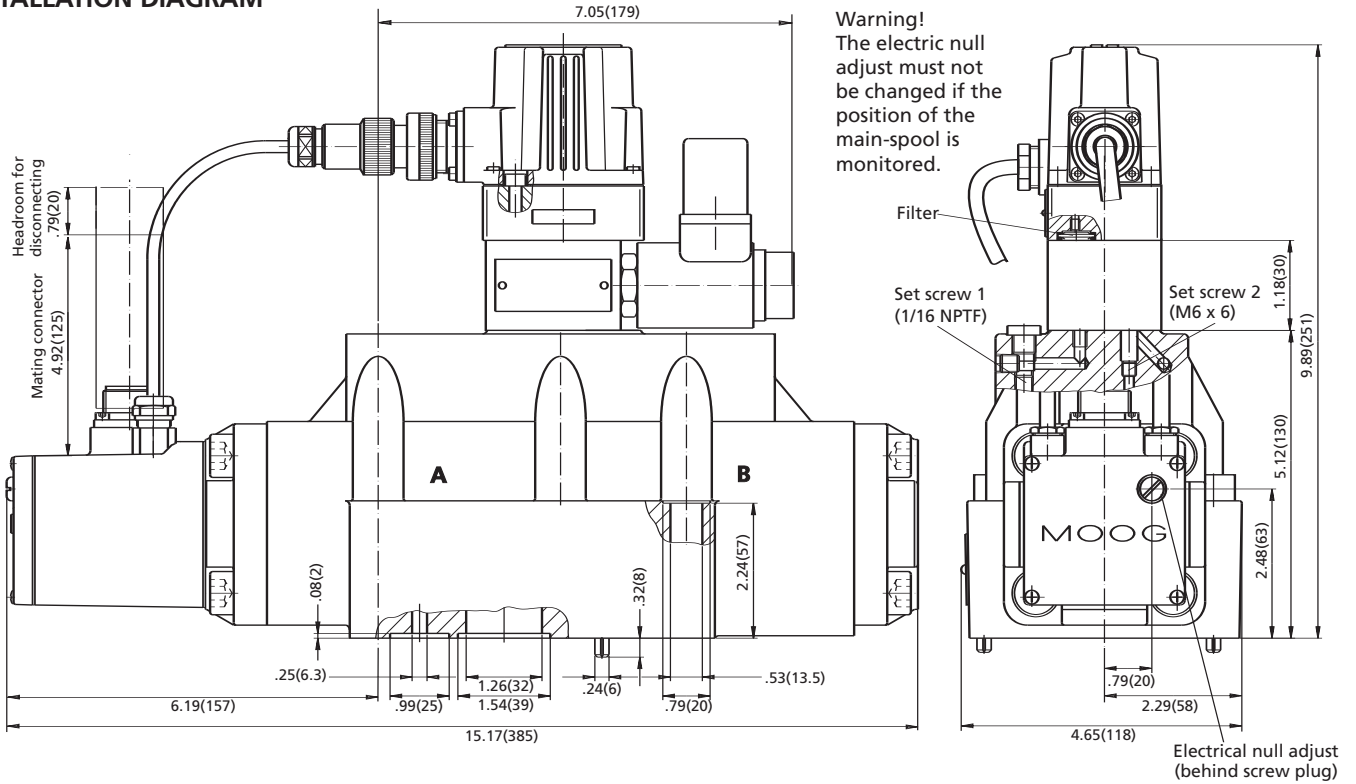

The mounting manifold must conform to ISO 4401-08-07-0-94 (see page 15).

Version with mechanical spring centering (**fail-safe version M**) see page 14 (symbol) and page 15 (installation drawing)

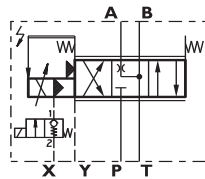

Fail-safe version W
Centered position, underlapped

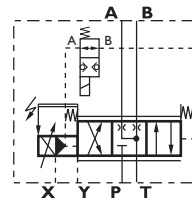

Fail-safe version W
Centered position, overlapped

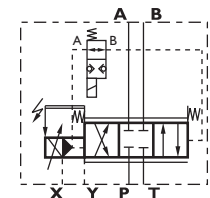

CONVERSION INSTRUCTION

For main stage operation with internal or external pilot connection.	Pilot Flow Supply	Set Screw bore 1 (1/16 NPTF)	Pilot Flow Return	Set Screw bore 2 (M6 x 6)
	Internal P External X	open closed	Internal T External Y	open closed

SPARE PARTS AND ACCESSORIES

Spare parts and accessories: Page 15

INSTALLATION DIAGRAM

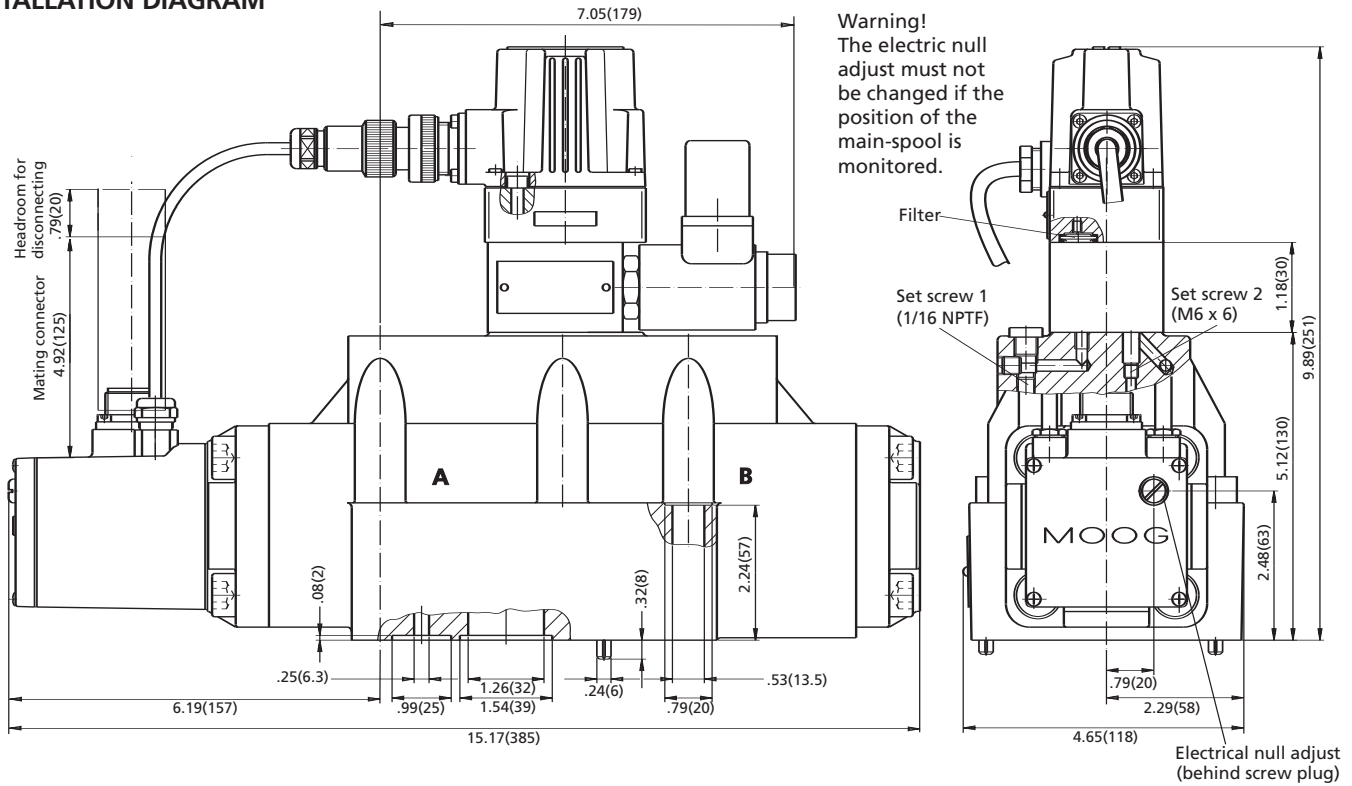

The mounting manifold must conform to ISO 4401-08-07-0-94 (see page 17).

Version with mechanical spring centering (**fail-safe version M**) see page 16 (symbol) and page 17 (installation drawing)

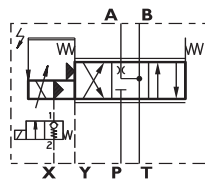

Fail-safe version W
Centered position, underlapped

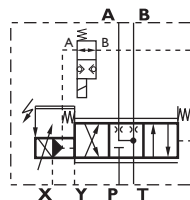

Fail-safe version W
Centered position, overlapped

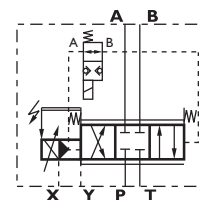

CONVERSION INSTRUCTION

For main stage operation with internal or external pilot connection.	Pilot Flow Supply	Set Screw bore 1 (1/16 NPTF)	Pilot Flow Return	Set Screw bore 2 (M6 x 6)
	Internal P External X	open closed	Internal T External Y	open closed

SPARE PARTS AND ACCESSORIES

Spare parts and accessories: Page 17

INSTALLATION DIAGRAM

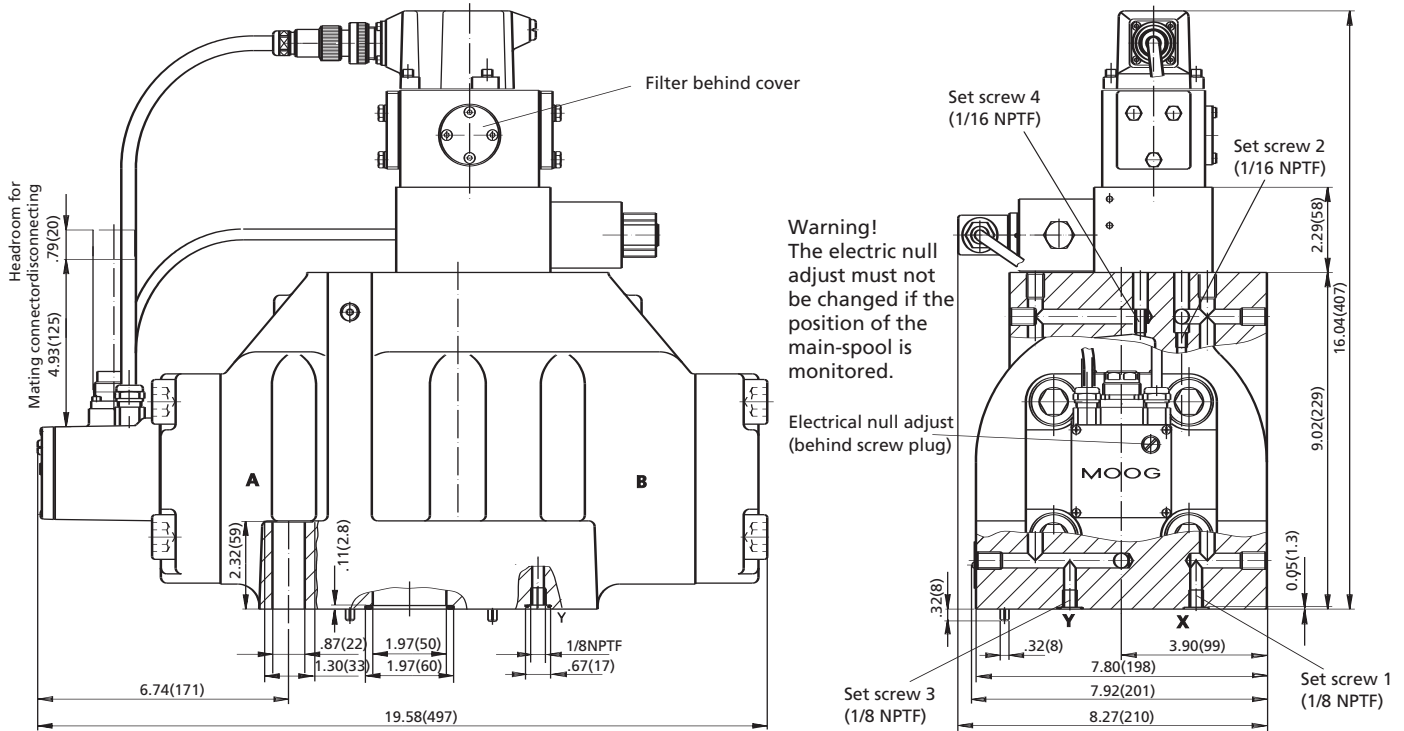

The mounting manifold must conform to ISO 4401-08-07-0-94 (see page 19).

Version with mechanical spring centering (fail-safe version M) see page 18 (symbol) and page 19 (installation drawing)

Fail-safe version W
Centered position, overlapped

Fail-safe version S
End position P → A, critical lap

Fail-safe version W
Centered position, overlapped

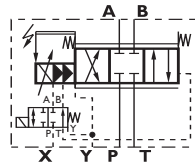
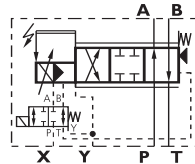
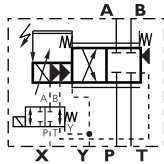

CONVERSION INSTRUCTION

For main stage operation with internal or external pilot connection.	Pilot Flow Supply	Set Screw bore		Pilot Flow Return	Set Screw bore	
		1 (1/8 NPTF)	2 (1/16 NPTF)		3 (1/8 NPTF)	4 (1/16 NPTF)
Internal P	closed	open	closed	Internal T	closed	open
External X	open	closed	open	External Y	open	closed

SPARE PARTS AND ACCESSORIES

Spare parts and accessories: Page 19

ORDERING INFORMATION FOR STANDARD MODELS

Model	Type Designation	Rated Flow gpm [l/min] @ 75 psi [5 bar] per land		Description
D661-2745E	P60HAAM4NSF2	16	60	Spool type: 4-way, critical lap, linear; ServoJet® pilot
D661-4737	P60HDAM4NSF2-O	16	60	Spool type: 4-way, 10% overlap, linear; ServoJet® pilot
D661-2722E	P80HAAM4NSF2	21	80	Spool type: 4-way, critical lap, linear; ServoJet® pilot
D661-4732	P80HDAM4NSF2-O	21	80	Spool type: 4-way, 10% overlap, linear; ServoJet® pilot
D662-2714E	D01HABM6NSF2	40	150	Spool type: 4-way, critical lap, linear; High-flow ServoJet® pilot
D662-4724	D01HDBM6NSF2-O	40	150	Spool type: 4-way, 10% overlap, linear; High-flow ServoJet® pilot
D662-2718E	D02HABM6NSF2	66	250	Spool type: 4-way, critical lap, linear; High-flow ServoJet® pilot
D662-2722E	D02HDBM6NSF2	66	250	Spool type: 4-way, 10% overlap, linear; High-flow ServoJet® pilot
D663-2709E	L03HABM6NSF2	92	350	Spool type: 4-way, critical lap, linear; High-flow ServoJet® pilot
D663-4705	L03HDBM6NSF2-O	92	350	Spool type: 4-way, 10% overlap, linear; High-flow ServoJet® pilot
D664-2708E	L05HABM6NSF2	145	550	Spool type: 4-way, critical lap, linear; High-flow ServoJet® pilot
D664-4714	L05HDBM6NSF2-O	145	550	Spool type: 4-way, 10% overlap, linear; High-flow ServoJet® pilot
D665E2301	K15FAHO6NSF2	400	1500	Spool type: 4-way, critical lap, linear; 2-stage MFB pilot
D665-4602	K15FDHO6NSF2-O	400	1500	Spool type: 4-way, 10% overlap, linear; 2-stage MFB pilot

Notes: All standard models use 24 V supply voltage and ± 10 V command signal. Spool position output is 2.5 V to 13.5 V.

ORDERING INFORMATION

D660

Model Number
D661 to D665

Specification Status	
-	Series specification
E	Preseries specification
K	Explosion proof version upon request
Z	Special specification

Model Designation	
	Assigned at the factory

Factory Identification

Valve Version	Series
P	Standard spool D661 to D665
B	Standard spool D661 (5-way)
D	Stub shaft spool Ø .63 in. [16mm] D662
L	Stub shaft spool Ø .75 in. [19mm] D663 and D664
K	Stub shaft spool Ø 1.38 in. [35mm] D665

Rated Flow			
	Q _N [gpm] at Δp _N = 75 psi/land	Q _N [l/min] at Δp _N = 5 bar/land	Series
30	8	30	D661
60	16	60	D661
80	21	80	D661
01	40	150	D662
02	66	250	D662
03	92	350	D663
05	145	550	D664
10	265	1000	D665
15	400	1500	D665

Maximum Operating Pressure p _p *		Pilot Valve
F	3,000 psi. At p _s ≤ 3,000 psi (external) operating pressure in port P, A, B and T up to 5,000 psi possible.	H
H	4,000 psi. At p _s ≤ 4,000 psi (external) operating pressure in port P, A, B and T up to 5,000 psi possible.	A/B/J/M
K	5,000 psi (not with pilot valves D630 and D631)	A/B/J
X	Special version	

*3000 psi = 210 bar, 4000 psi = 280 bar, 5000 psi = 350 bar

Main Spool Type	
A	4-way: ~ critical lap, linear characteristic
D	4-way: 10% overlap, linear characteristic
P	4-way: P ↔ A, A ↔ T: ~ critical lap, curvilinear characteristic P ↔ B: 60% overlap, curvilinear characteristic B ↔ T: 50% underlap, linear characteristic
U	5-way: P ↔ A, P ₂ ↔ B, A ↔ T: ~ critical lap, curvilinear characteristic
Y	4-way: ~ critical lap, curvilinear characteristic
Z	2x2-way: A ↔ T, B ↔ T ₂ : ~ critical lap, linear characteristic
X	Special spool on request

Pilot Stage or Pilot Valve	For Valve Type
A	ServoJet® Standard D661...P
B	ServoJet® High flow D661...P D662...D D663/4...L
M	D630 2-stage, MFB D662/D663/D664...P
H	D631 2-stage, MFB D665...P
J	D661 ServoJet® 2-stage, EFB D665...K

Preferred configurations are highlighted. Options may increase price. Technical changes are reserved. All combinations may not be available. Please contact Moog.

Type Designation

.....2..

Function Code	Connector
O	No enable input. Pin C not used S
A	Without enable signal applied the spool moves to adjustable centered position (see page 5). S
B	Without enable signal applied the spool moves into defined end position A ↔ T or B ↔ T (see page 5). S
E	Without enable signal applied the spool moves to adjustable centered position. Position error monitored (see page 6) E
F	Without enable signal applied the spool moves into defined end position A ↔ T or B ↔ T. Position error monitored (see page 6) E
G	Without enable signal applied the spool moves to adjustable centered position. Spool position monitored (see page 7) E
H	Without enable signal applied the spool moves into defined end position A ↔ T or B ↔ T. Spool position monitored (see page 7) E

Supply Voltage	
2	24 V _{DC} (18 to 32 V _{DC})
0	special version ±15 V on request

Signals for 100% Spool Stroke			
	Command	Output	Connector
A	±10 V	±10 V (diff.)	E
D	±10 V	2 to 10 V (6 V centered position)	E/S
F	±10 V	2.5 to 13.5 V	S
M	±10 V	4 to 20 mA	E/S
T	±10 V	±10 V with dead band compens. (diff.)	E
X	±10 mA	4 to 20 mA	E/S
Y	others on request		

Valve Connector	For Supply Voltage
E	11+PE-pole EN 175201 Part 804 0 2
S	6+PE-pole EN 175201 Part 804 — 2

Seal Material	
N	NBR (Buna) Standard
V	FPM (Viton) optional
Other materials on request	

Pilot Connections and Pilot Pressure			
	Supply X	Return Y	
4	internal	internal	Parameters of the control electronics are adapted to the pilot pressure. See operating pressure on the nameplate and in this ordering information.
5	external	internal	
6	external	external	
7	internal	external	

Spool Position of Main Stage with/without Electrical or Hydraulic Supply*				
O	Undefined (no fail-safe function)		for all valve types	
Mechanical fail-safe version				
	Position	p _p [psi] or p _x external [psi]	for valves with pilot valve	
F	P ↔ B, A ↔ T	≥ 360	A and B	
		< 15	A and B	
D	P ↔ A, B ↔ T	≥ 360	A and B	
		< 15	A and B	
M	Mid position defined	≥ 15	< 15	A and B
	Mid position undefined	≥ 15	≥ 360	A and B
	Mid position defined	≥ 15	≥ 215	H, J and M (2x2-way only)
Electrically controlled fail-safe version				
	Position	p _p [psi]	p _x ext SV*	VE** for valves with pilot valve
W	Mid position defined	≥ 15	≥ 215 off	on all types
	Mid position undefined	≥ 15	< 15 on	on only A and B
	Mid position defined	≥ 15	≥ 215 on	off all types
S	P ↔ A, B ↔ T	≥ 15	≥ 215 off	on all types
	P ↔ A, B ↔ T	≥ 15	≥ 215 on	off all types
P	defined A ↔ T	≥ 15	≥ 215 off	on only A and B (D661 only with p _x ext)
	P ↔ B, A ↔ T	< 15	< 15 on	off only A and B

*SV: Solenoid Valve
**VE: Valve Electronics

*15 psi = 1 bar, 215 psi = 15 bar, 360 psi = 25 bar

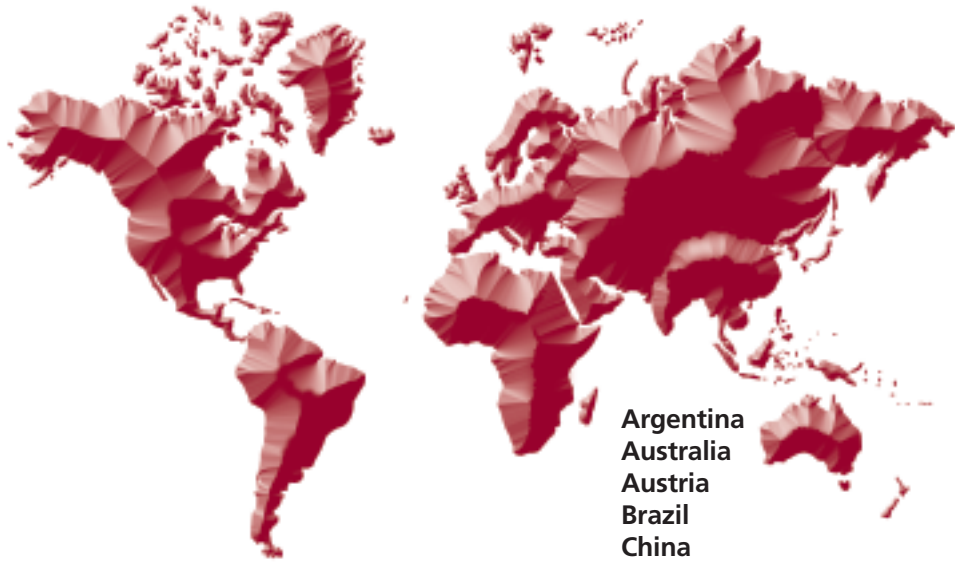

Argentina
Australia
Austria
Brazil
China
Finland
France
Germany
India
Ireland

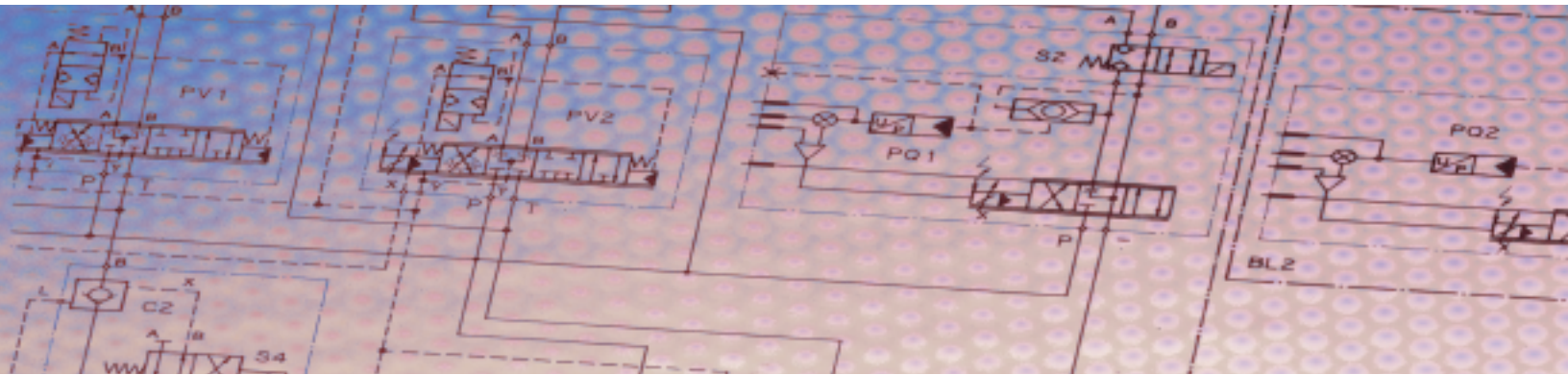

Italy
Japan
Korea
Luxembourg
Norway
Russia
Singapore
South Africa
Spain
Sweden
United Kingdom
USA

MOOG

Moog Inc., Industrial Controls
USA: +1-716-652-2000
Germany: +49-7031-622-0
Japan: +81-463-55-3615
For the location nearest you, visit
www.moog.com/worldwide.

CDL6562 Rev H 500-212 0405